

2025富宇建設DEFI羽球錦標賽

取8名

國小低年級組單打 共38籤

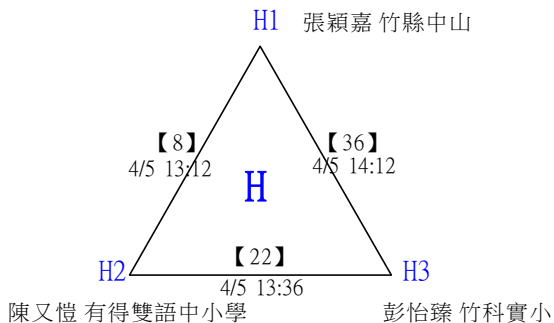
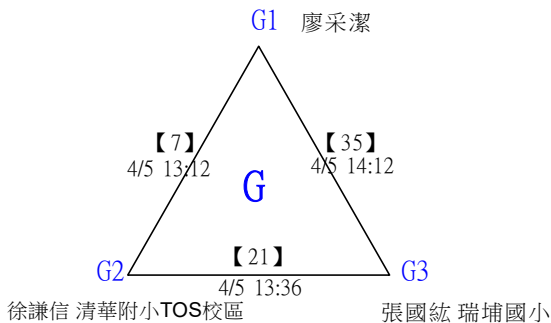
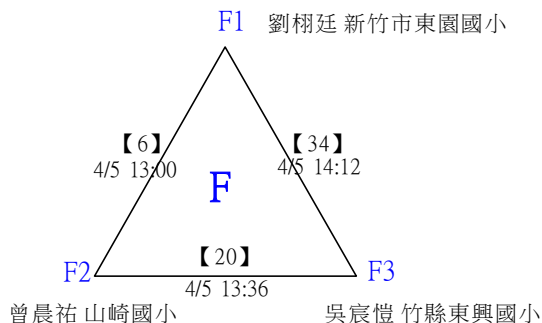
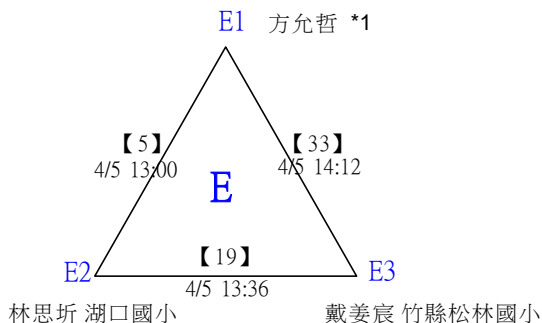
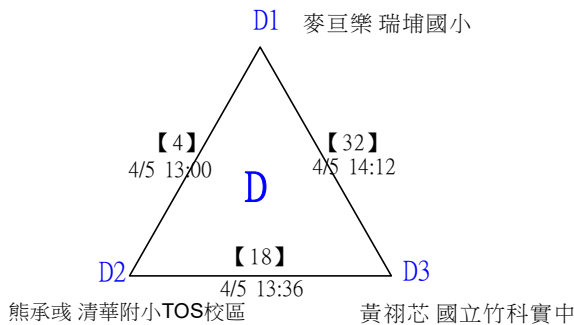
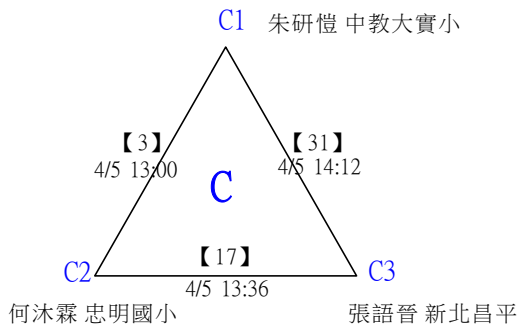
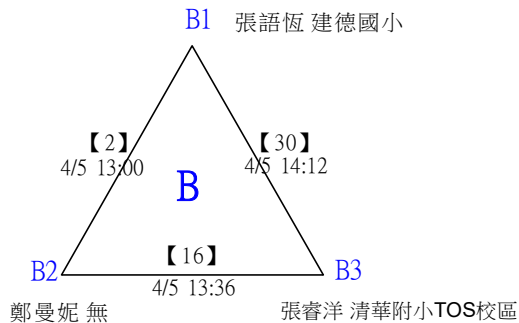
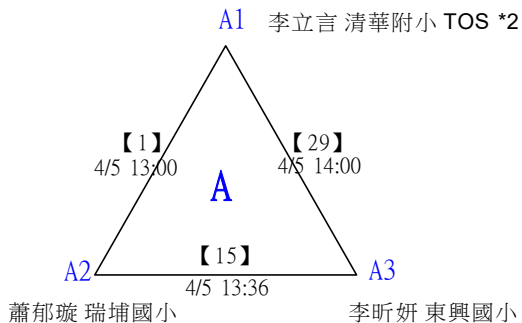

2025富宇建設DEFI羽球錦標賽

取8名

國小低年級組單打 共38籤

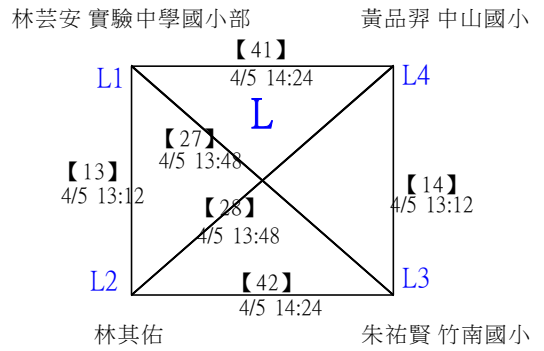
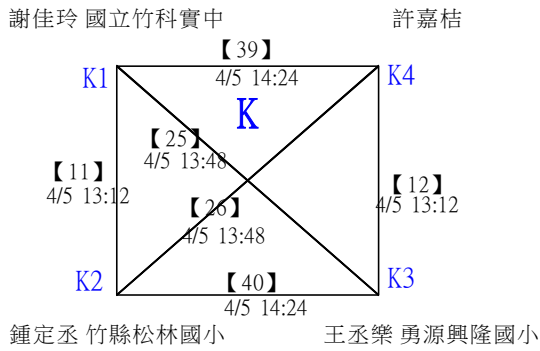
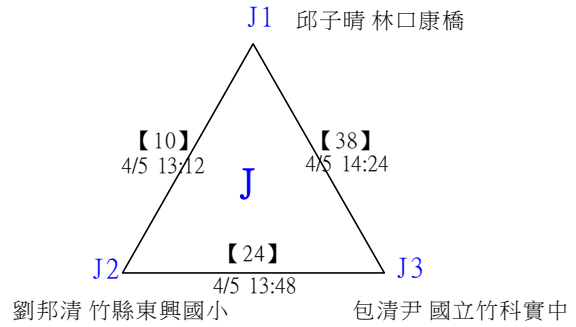
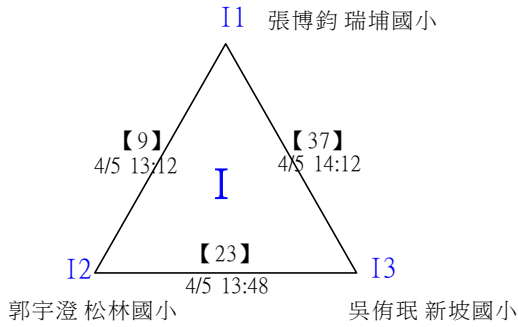

2025富宇建設DEFI羽球錦標賽

取8名

國小低年級組單打

決賽：三角取一，四角取二，抽籤決定位置。

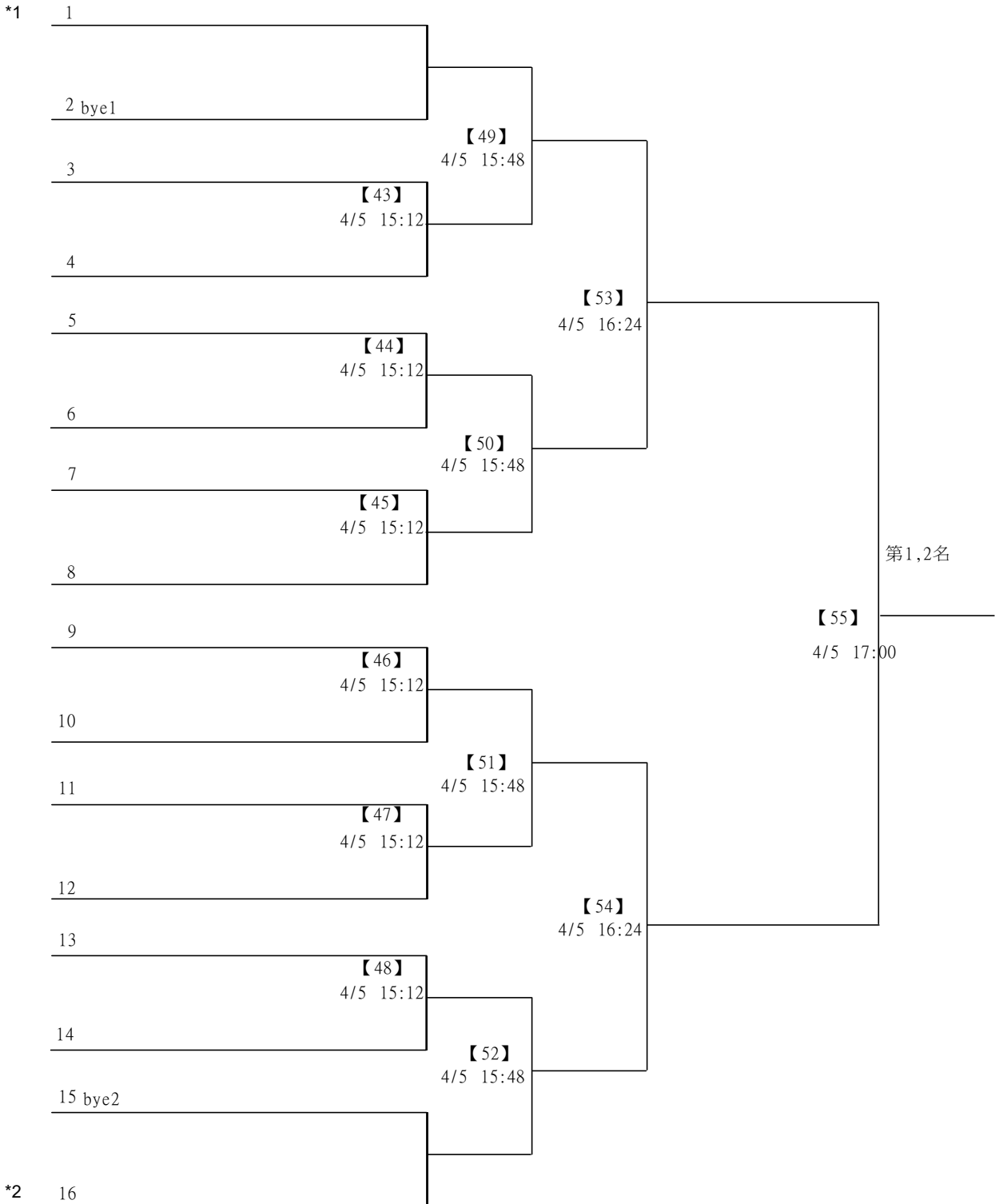

2025富宇建設DEFI羽球錦標賽

取4名

國小中年級組女單 共22籤

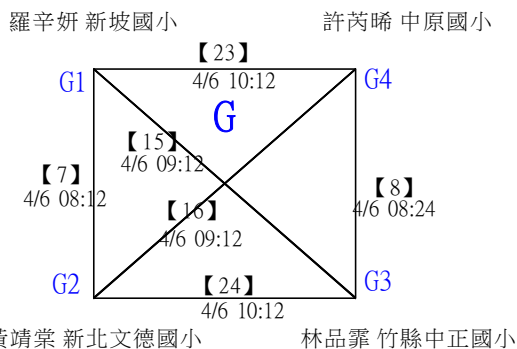
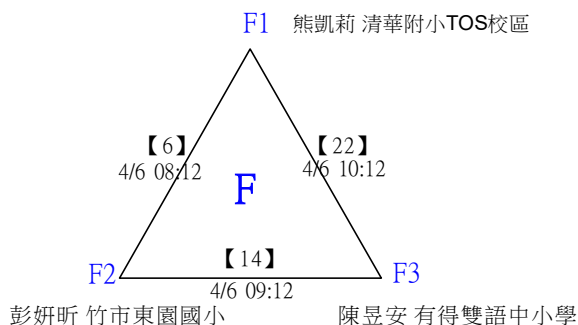
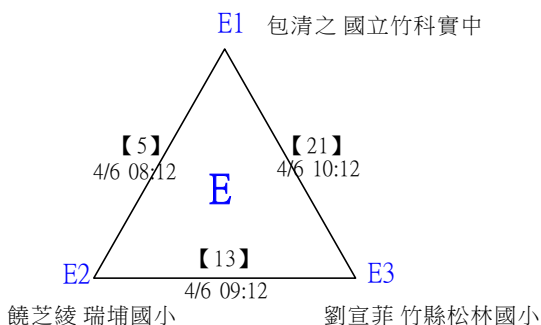
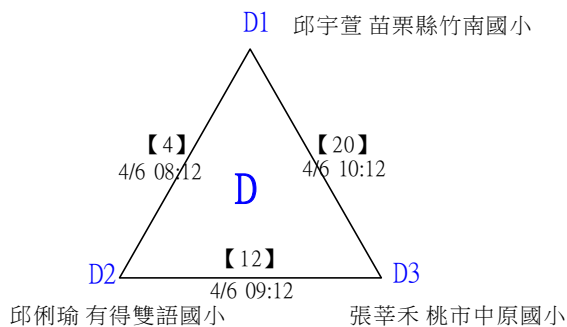
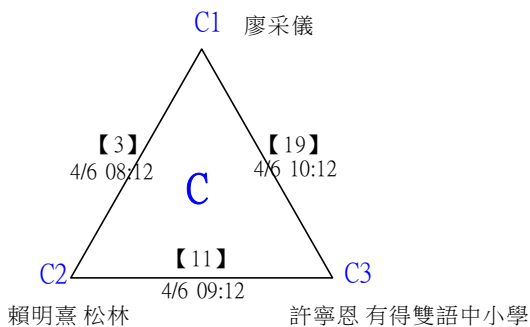
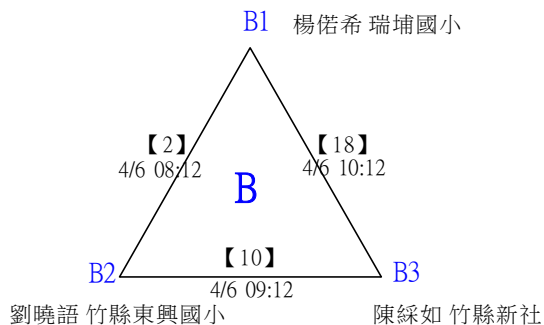
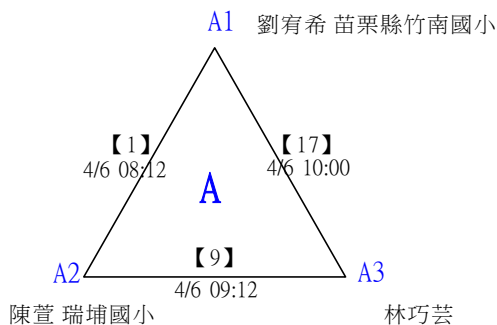

2025富宇建設DEFI羽球錦標賽

取4名

國小中年級組女單

決賽：三角取一，四角取二，抽籤決定位置。

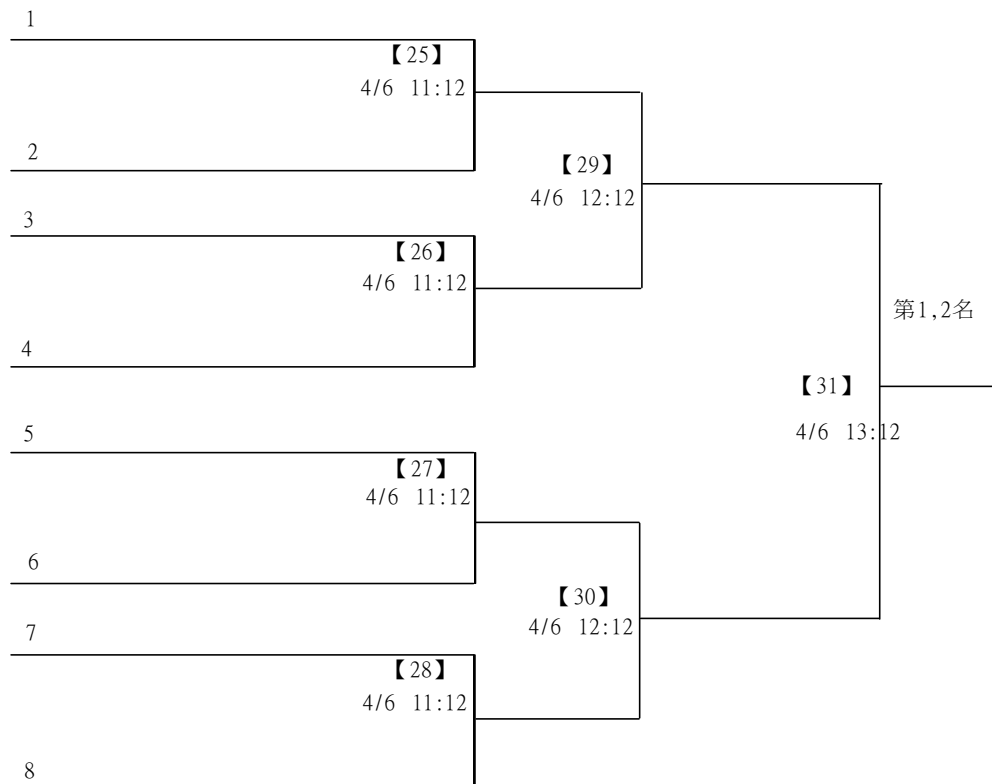

2025富宇建設DEFI羽球錦標賽

取16名

國小中年級組男單 共93籤

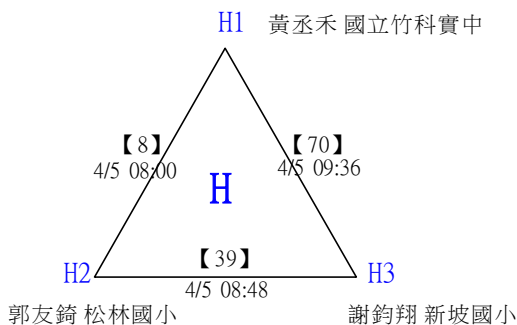
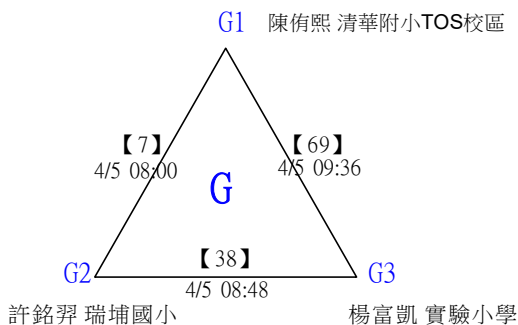
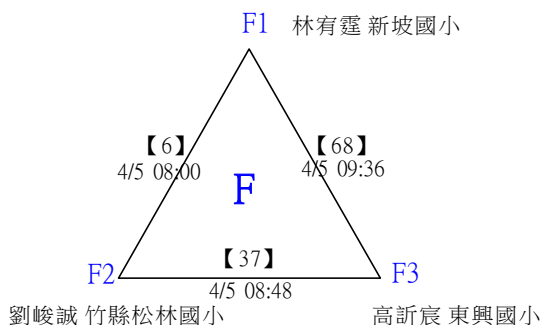
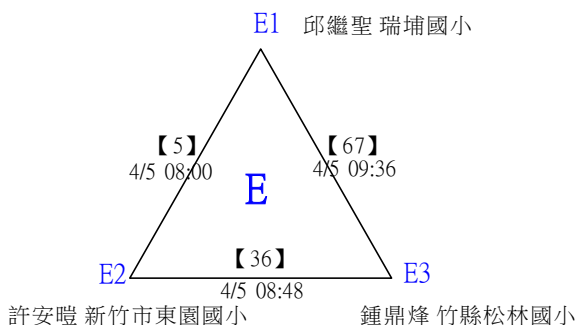
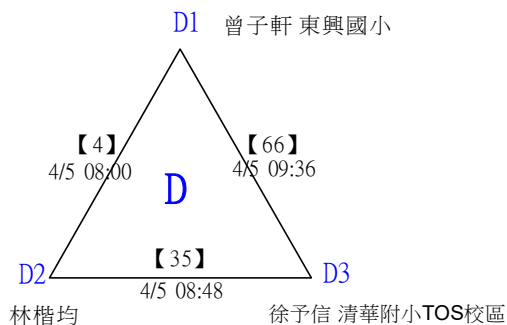
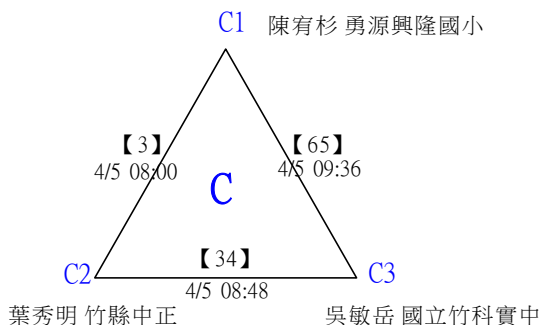
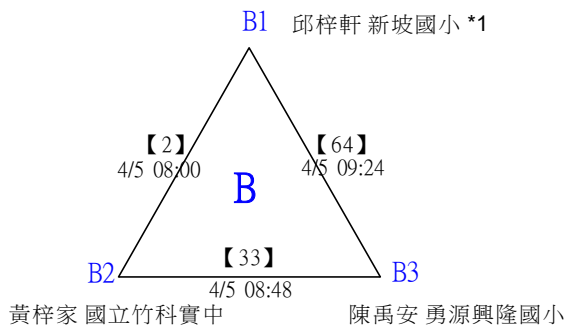
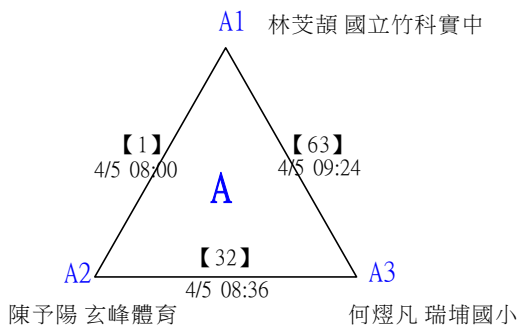

2025富宇建設DEFI羽球錦標賽

取16名

國小中年級組男單 共93籤

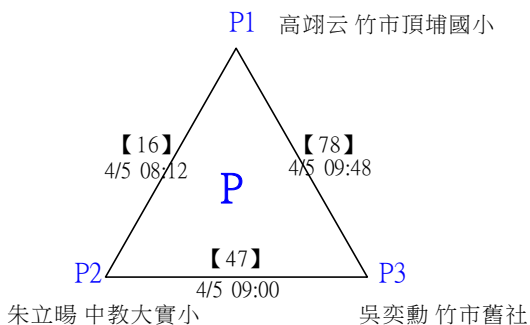
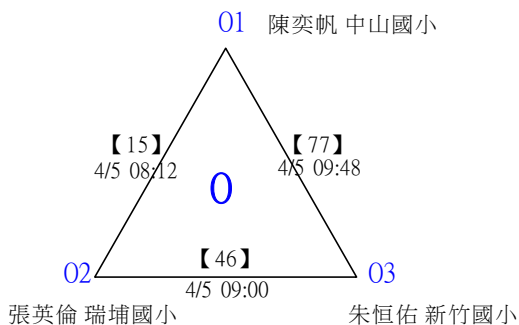
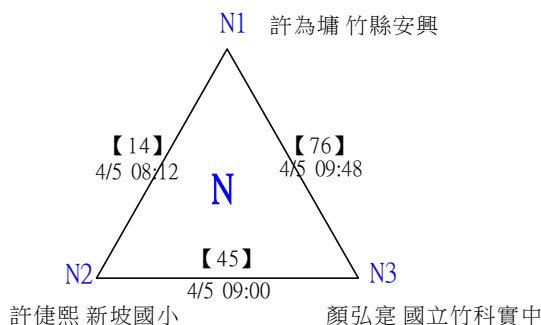
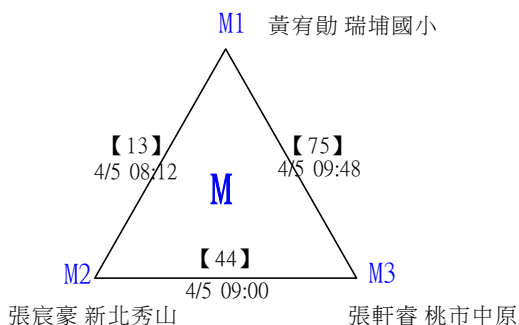
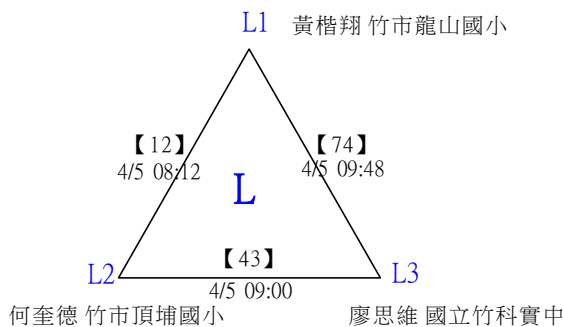
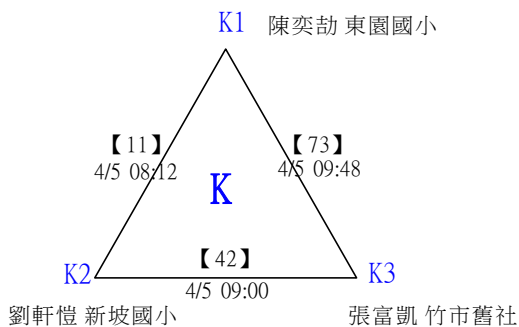
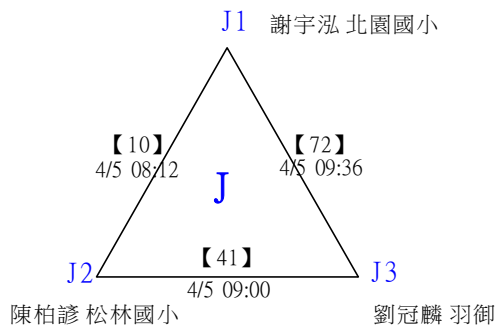
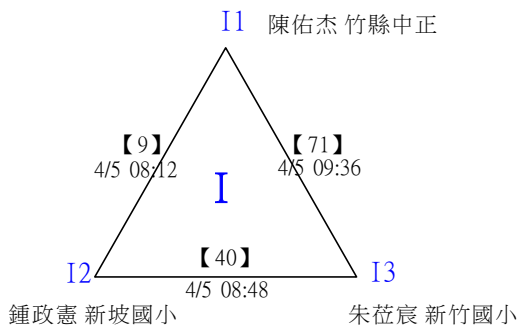

2025富宇建設DEFI羽球錦標賽

取16名

國小中年級組男單 共93籤

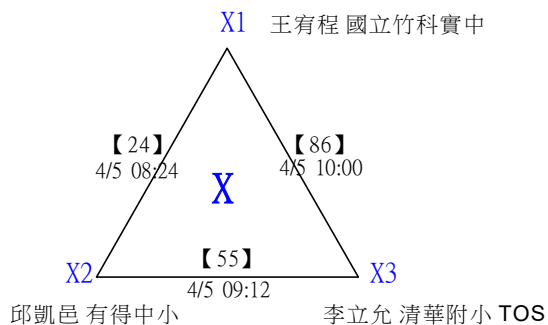
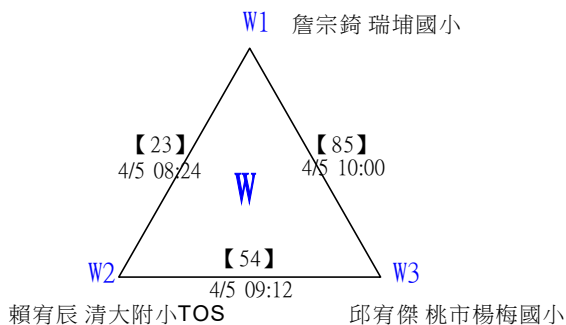
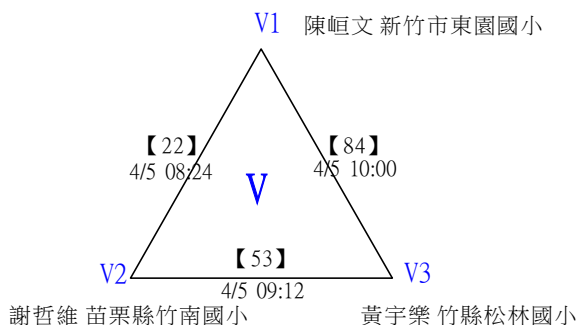
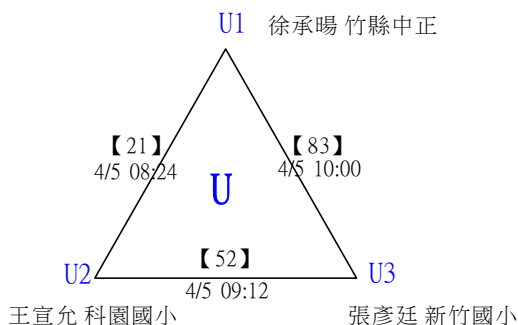
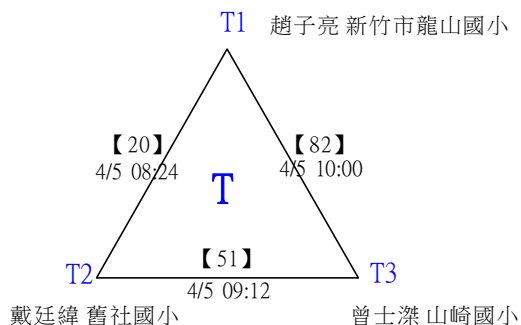
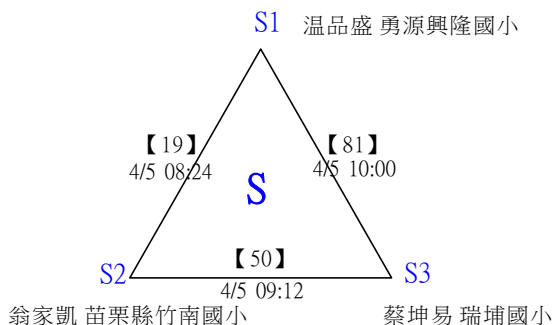
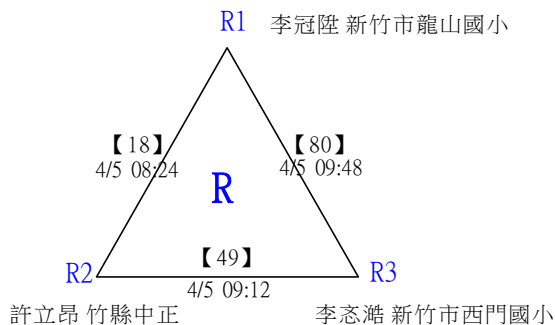
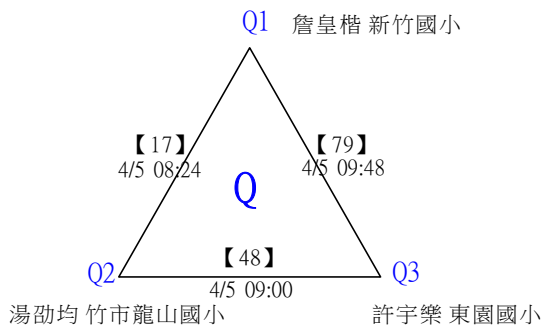

2025富宇建設DEFI羽球錦標賽

取16名

國小中年級組男單 共93籤

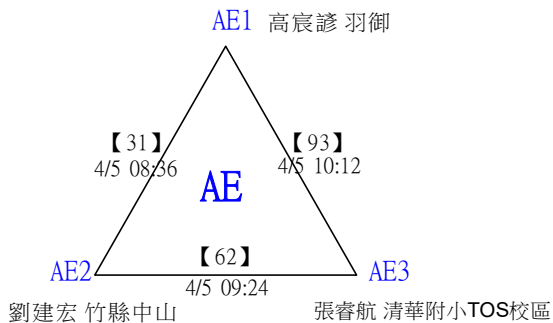
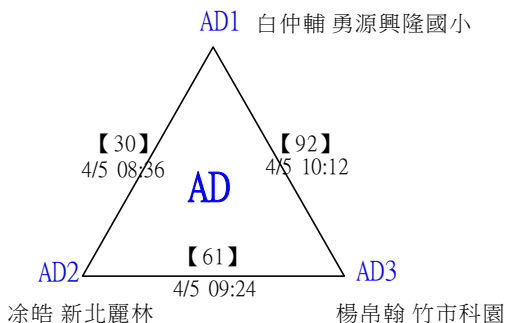
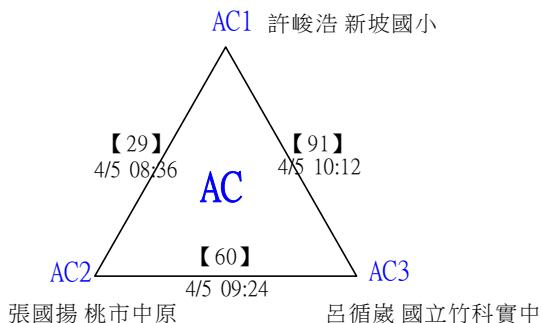
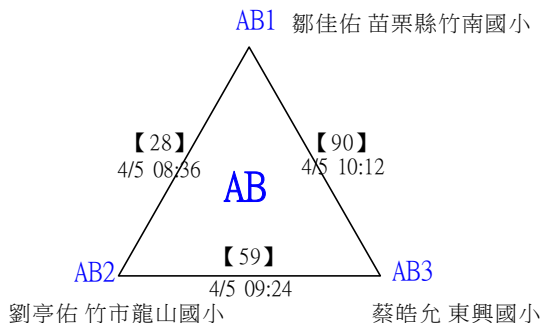
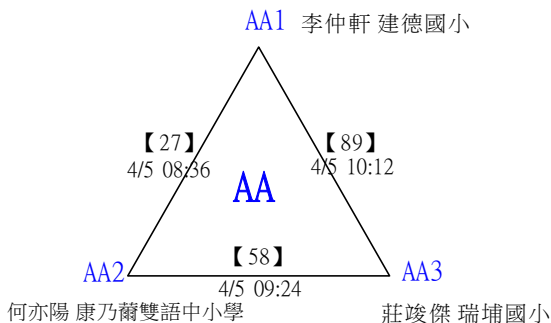
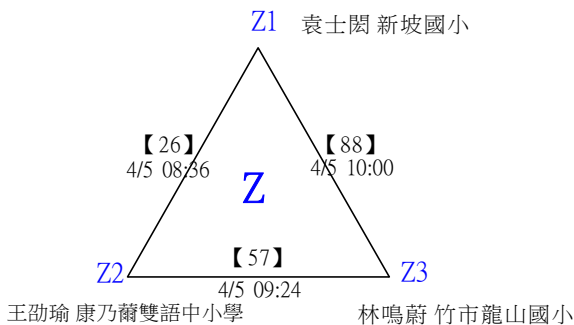
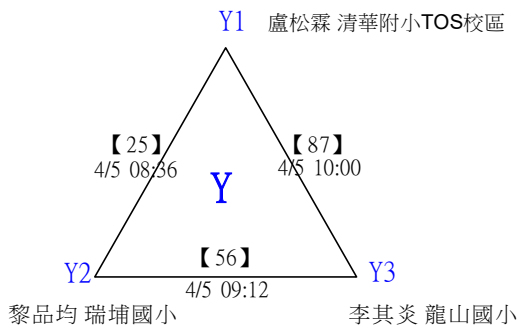

2025富宇建設DEFI羽球錦標賽

取16名

國小中年級組男單

決賽：三角取一，抽籤決定位置。

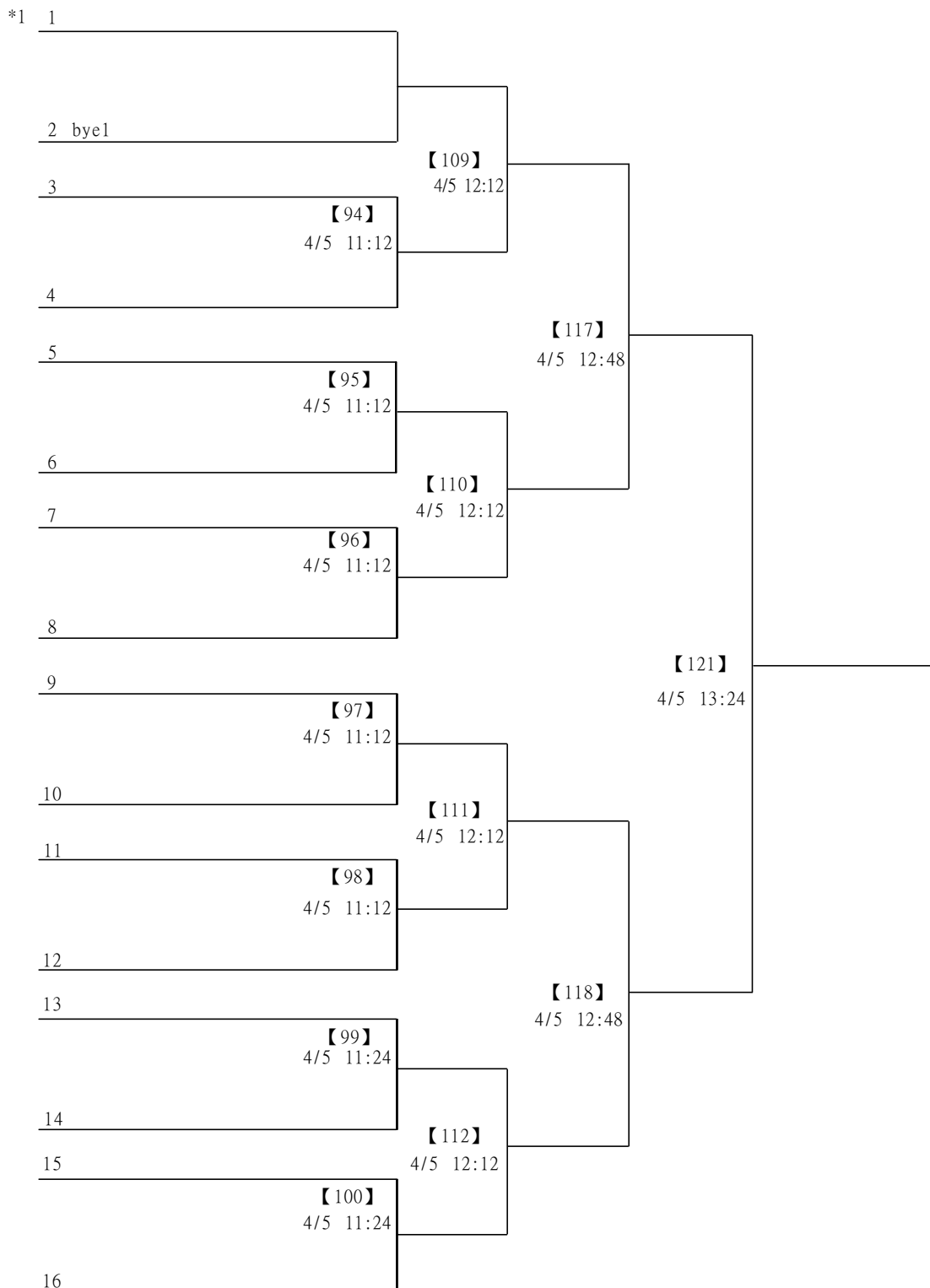

2025富宇建設DEFI羽球錦標賽

取16名

國小中年級組男單

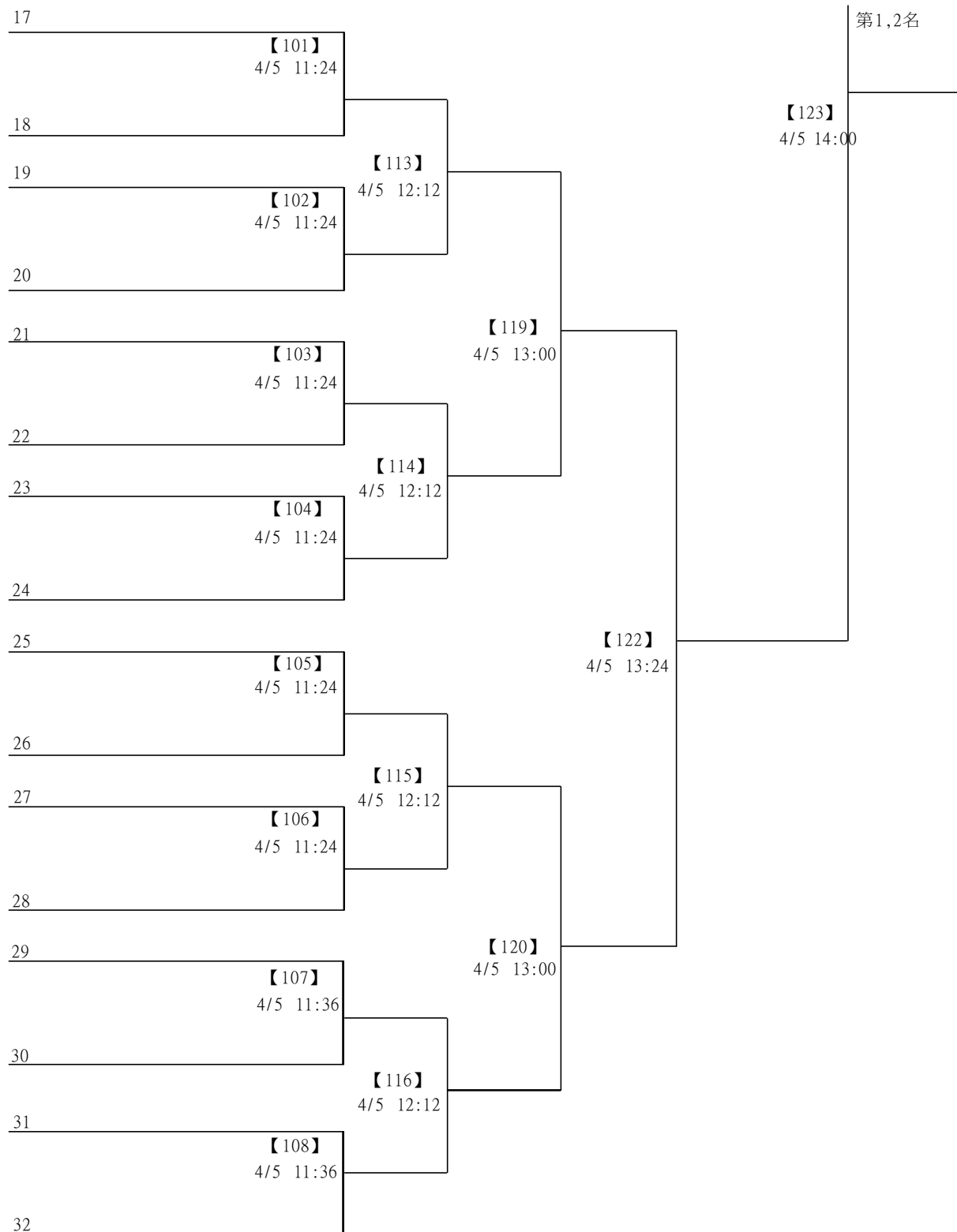

2025富宇建設DEFI羽球錦標賽

取8名

國小高年級組女單 共35籤

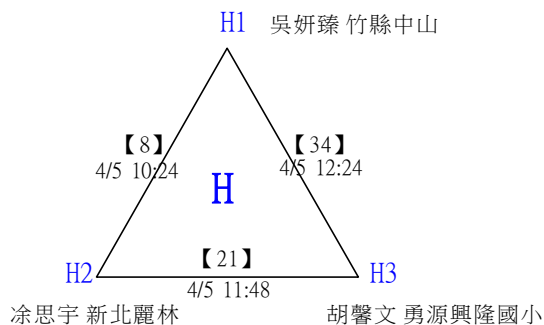
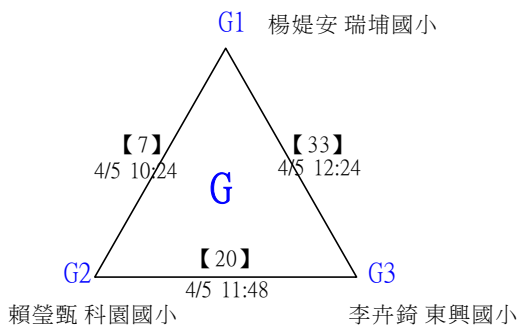
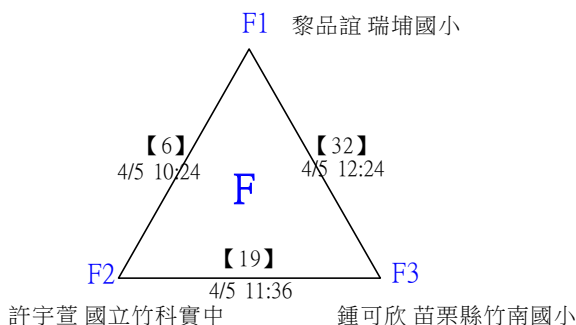
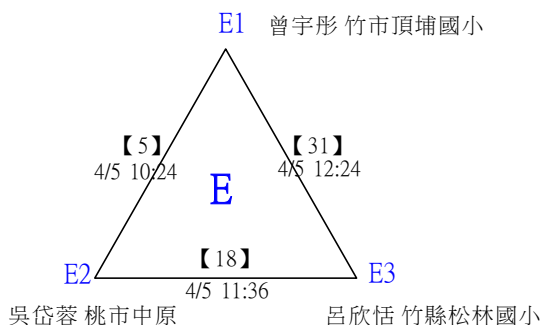
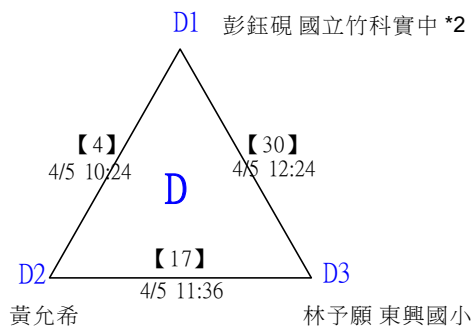
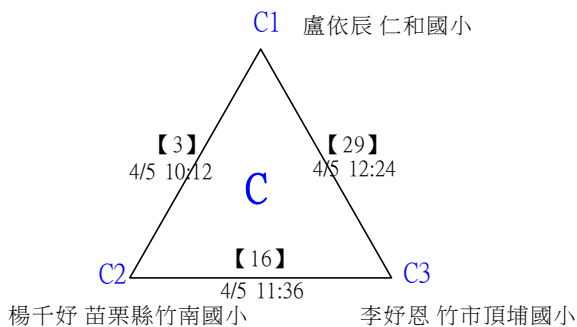
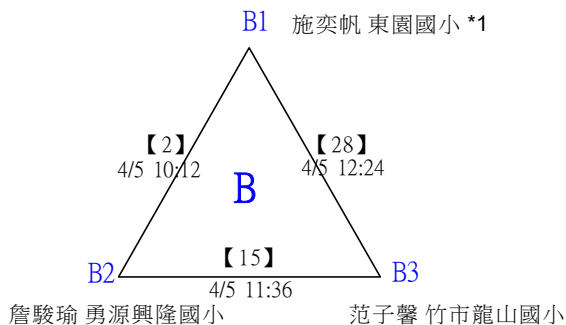
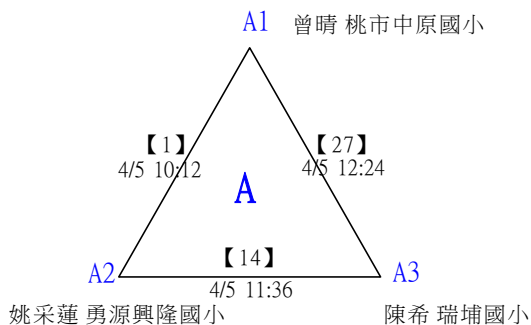

2025富宇建設DEFI羽球錦標賽

取8名

國小高年級組女單 共35籤

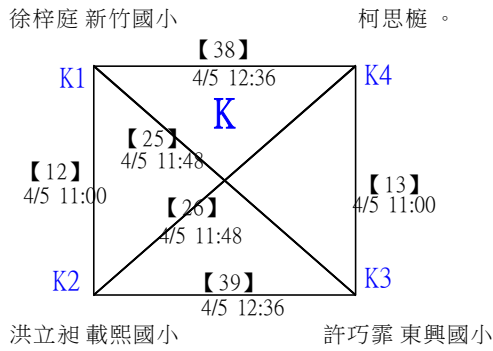
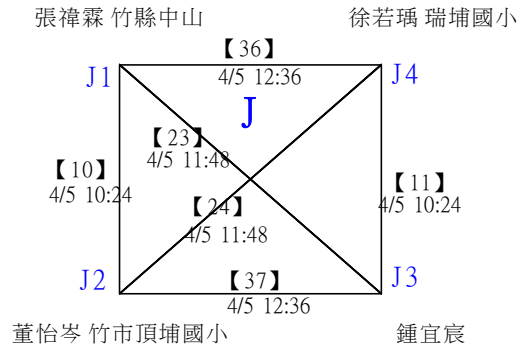
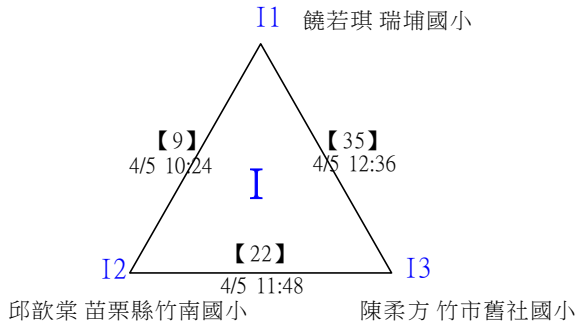

2025富宇建設DEFI羽球錦標賽

取8名

國小高年級組女單

決賽：三角取一，四角取二，抽籤決定位置。

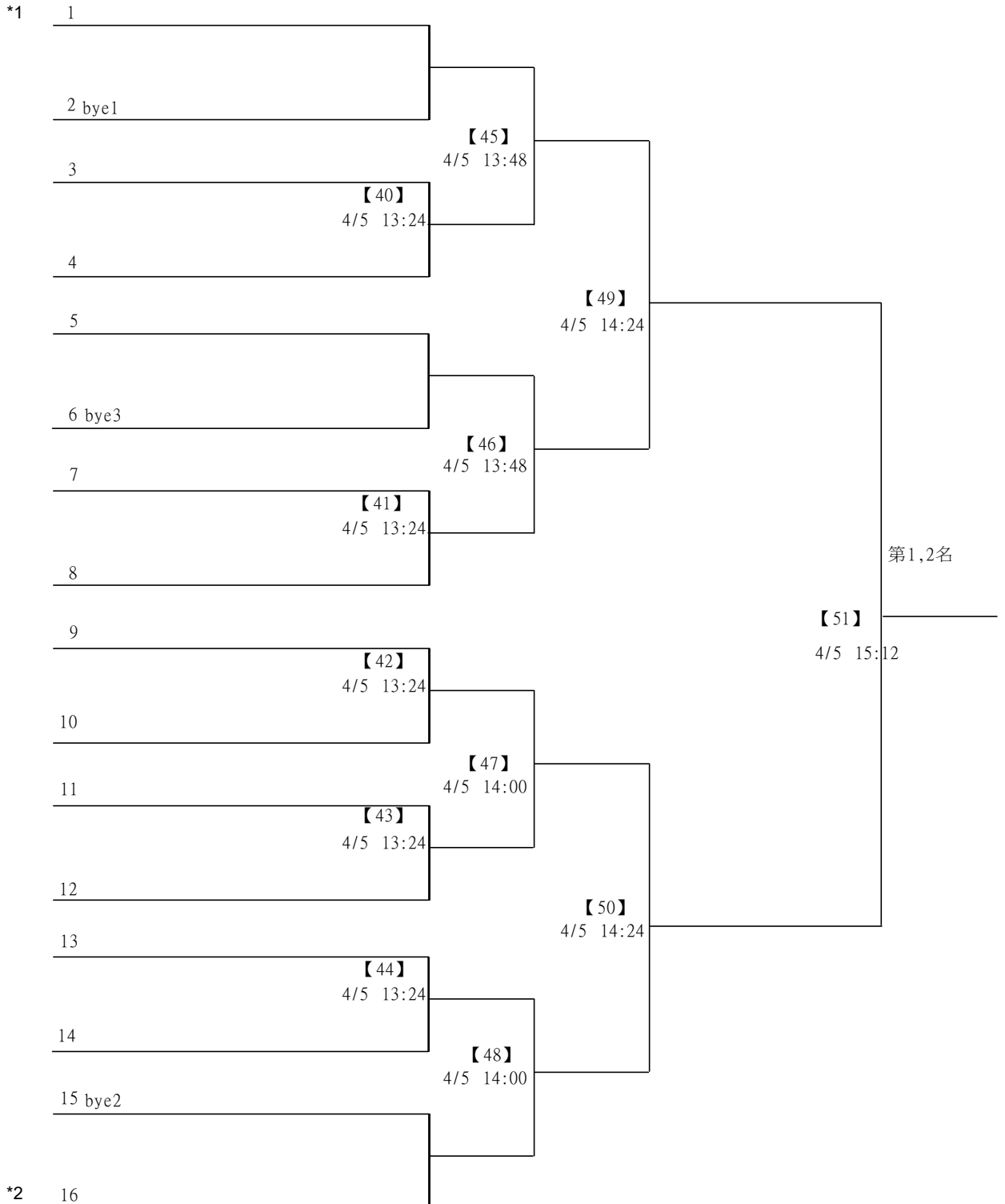

2025富宇建設DEFI羽球錦標賽

取16名

國小高年級組男單 共88籤

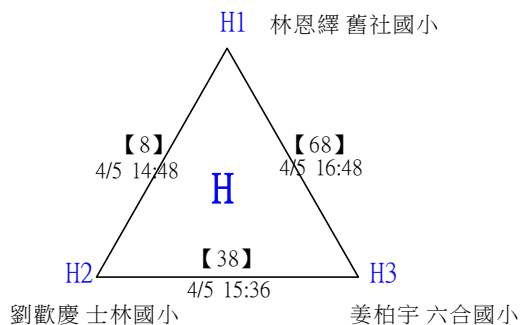
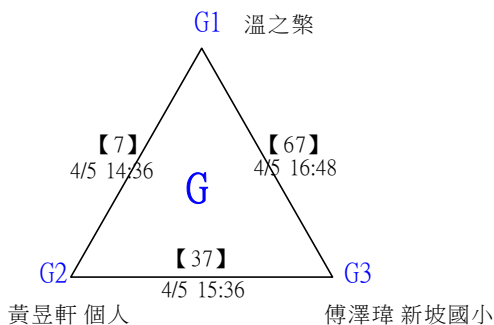
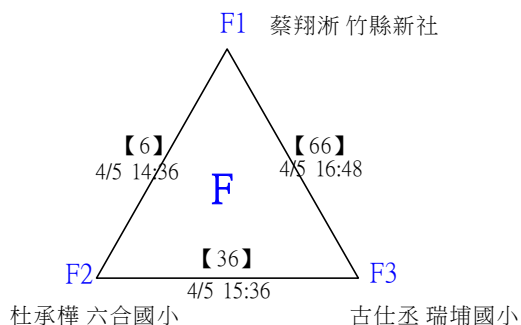
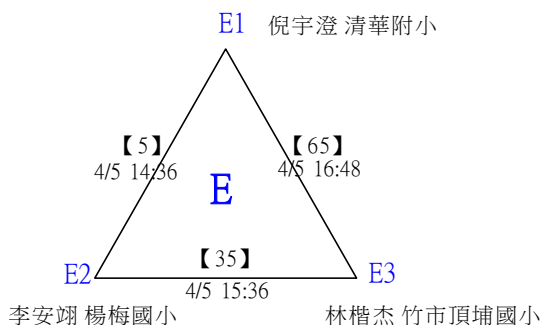
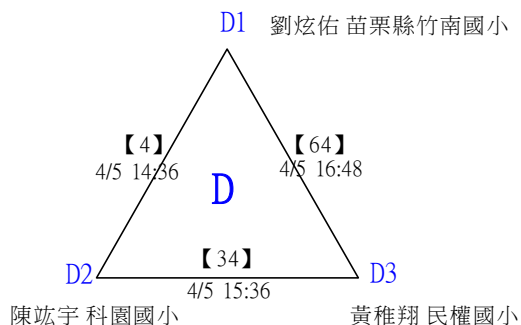
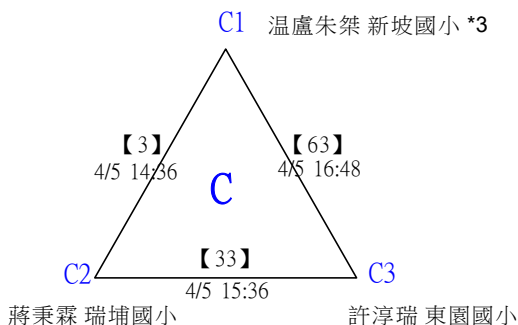
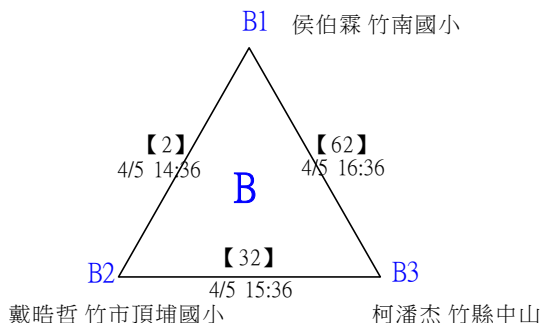
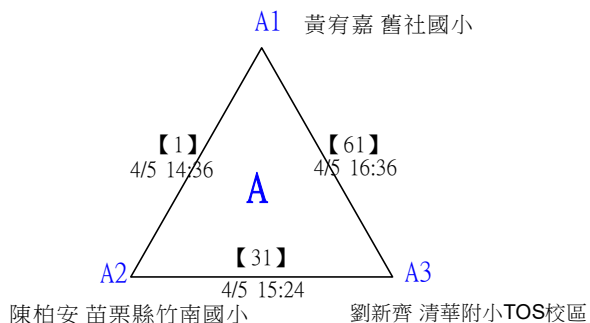

2025富宇建設DEFI羽球錦標賽

取16名

國小高年級組男單 共88籤

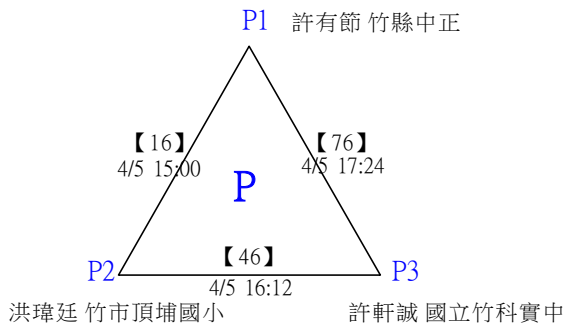
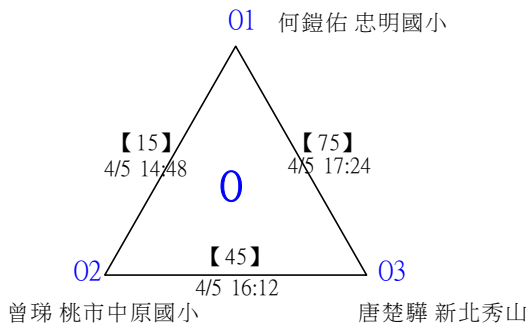
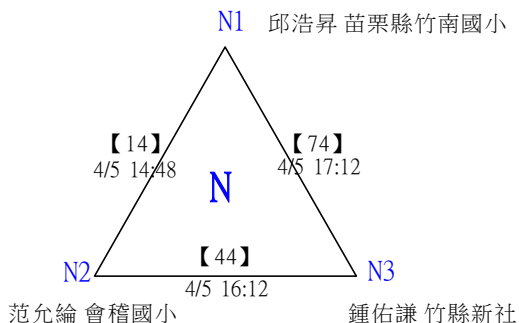
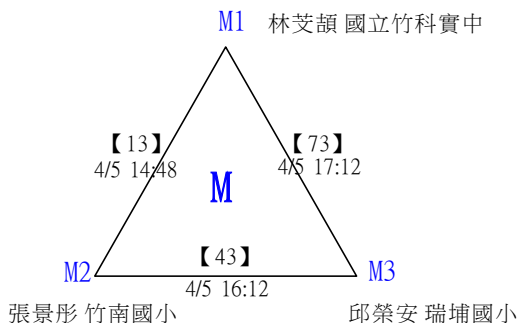
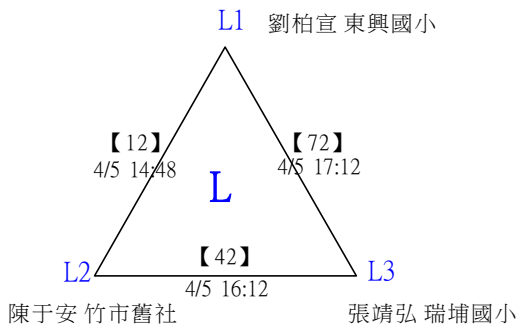
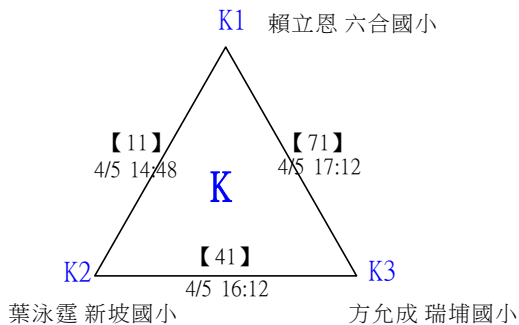
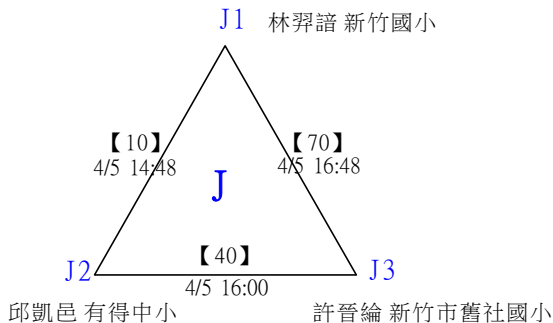
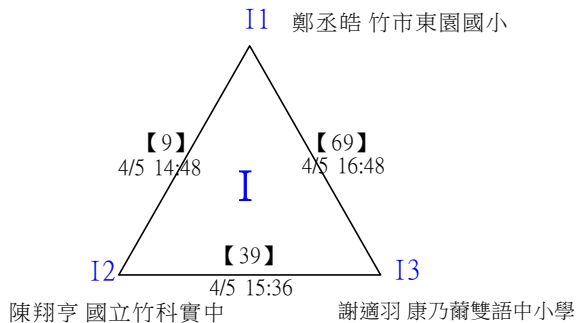

2025富宇建設DEFI羽球錦標賽

取16名

國小高年級組男單 共88籤

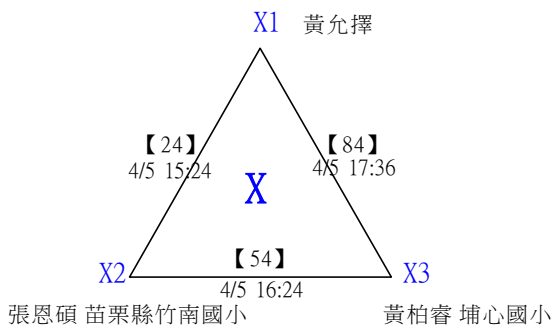
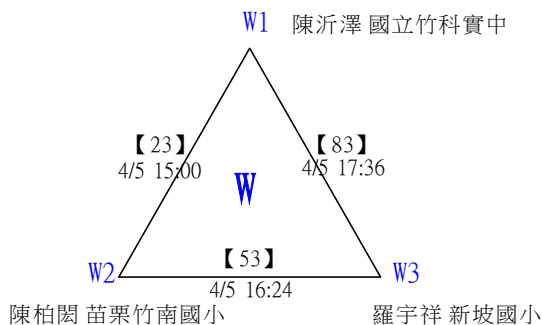
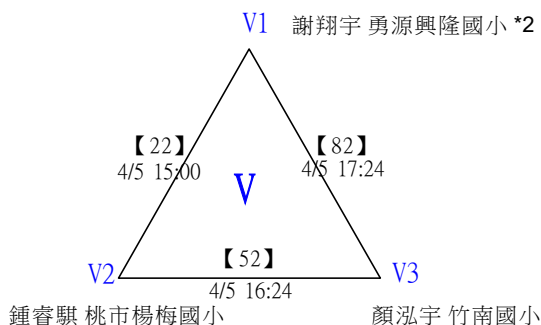
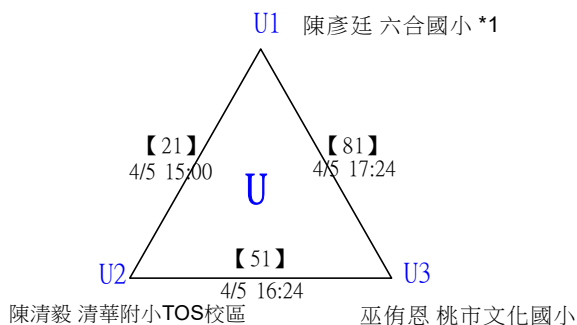
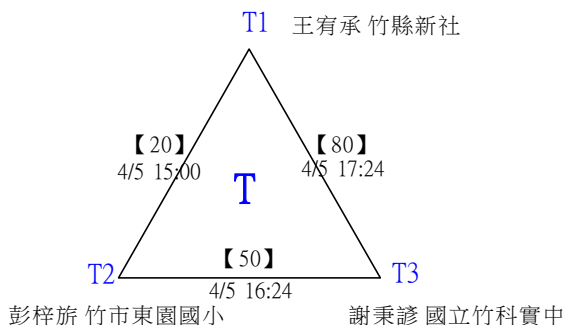
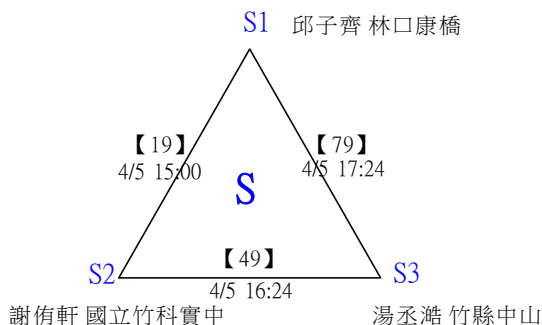
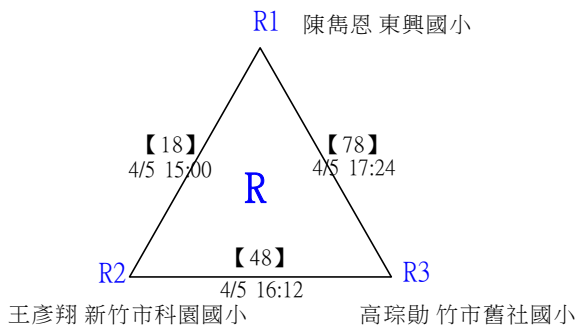
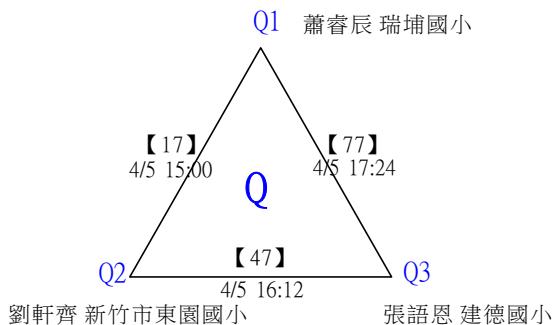

2025富宇建設DEFI羽球錦標賽

取16名

國小高年級組男單 共88籤

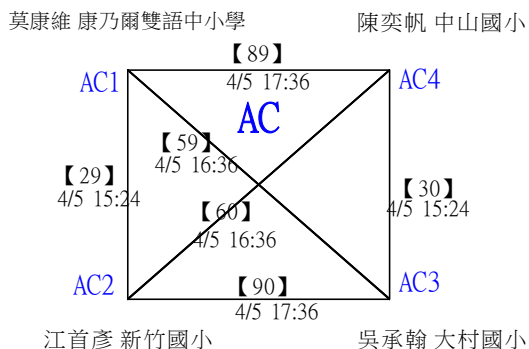
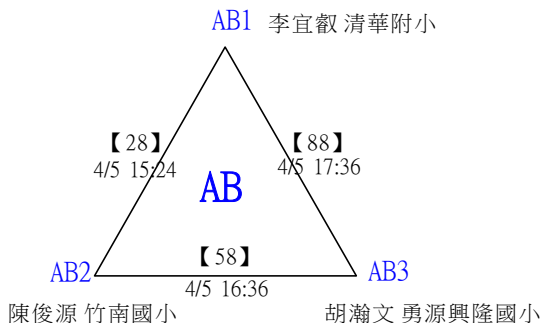
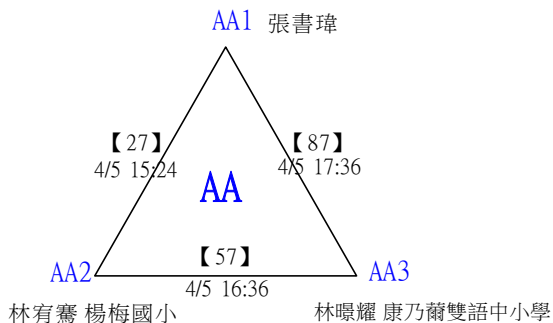
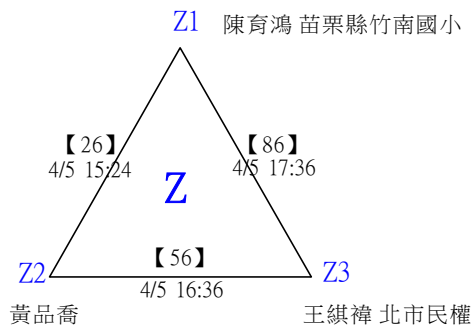
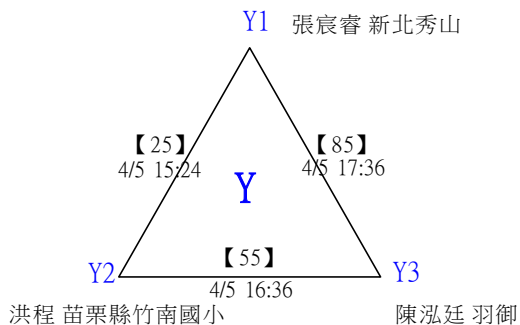

2025富宇建設DEFI羽球錦標賽

取16名

國小高年級組男單

決賽：三角取一，四角取二，抽籤決定位置。

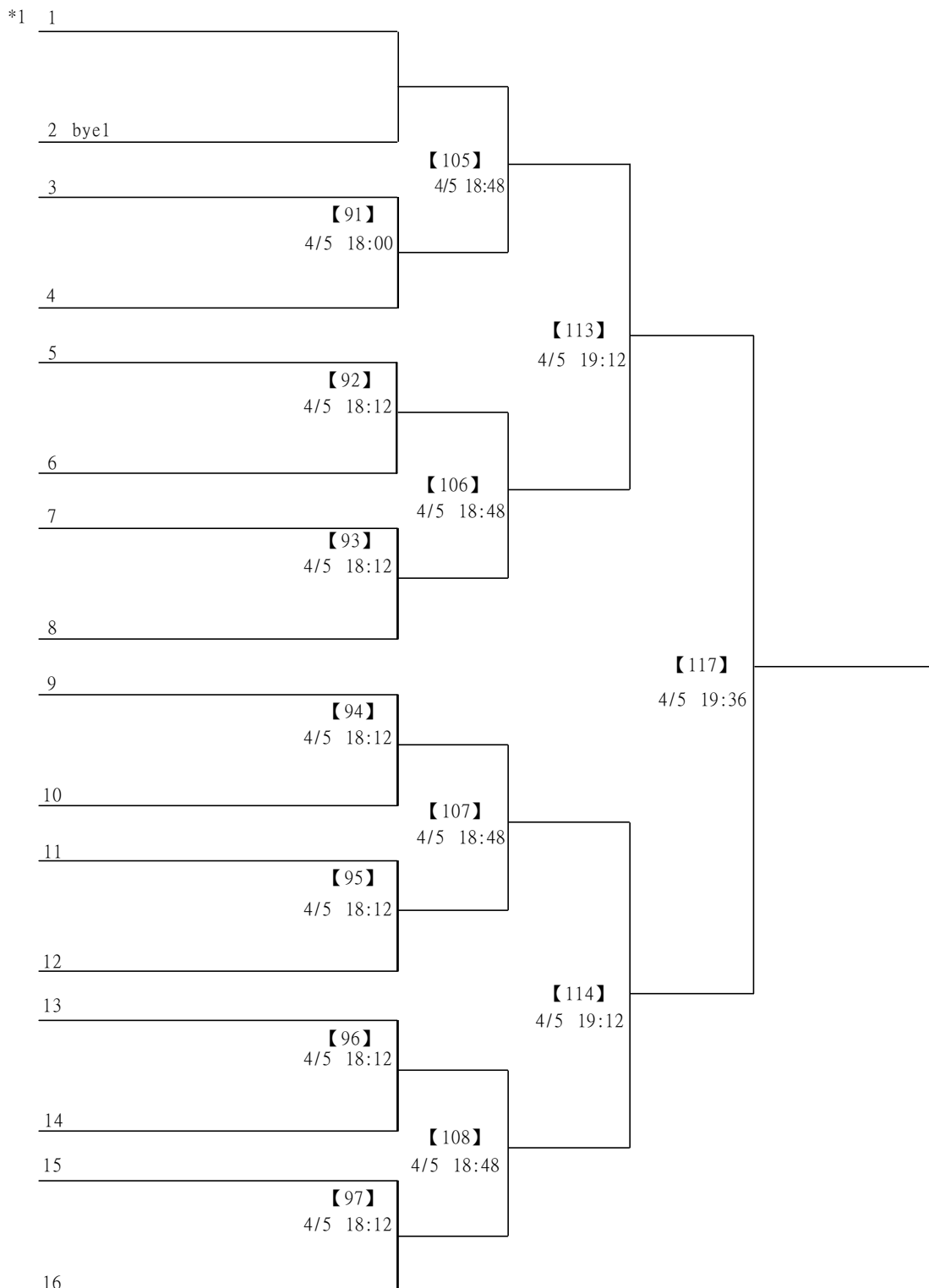

2025富宇建設DEFI羽球錦標賽

取16名

國小高年級組男單

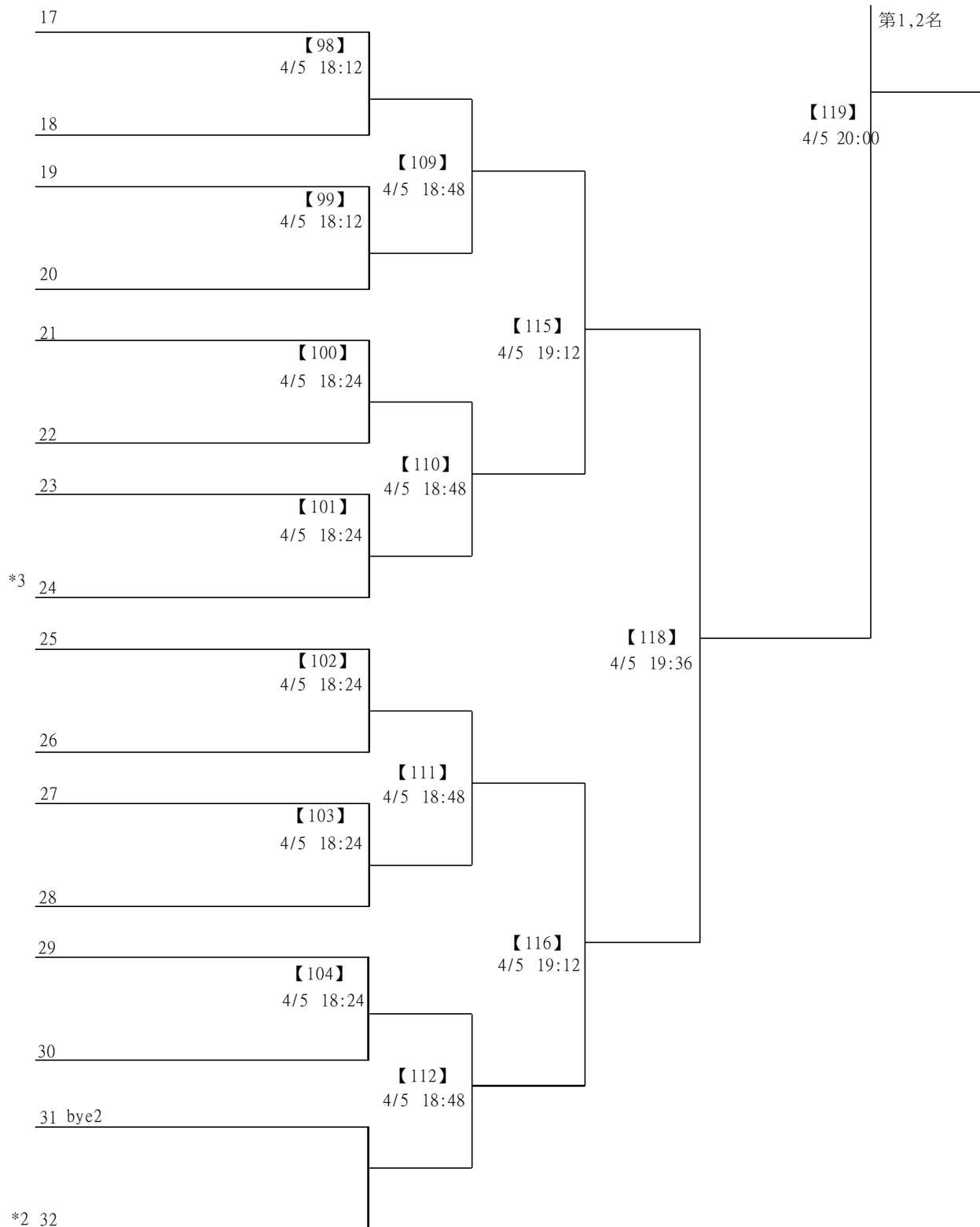

2025富宇建設DEFI羽球錦標賽

取8名

公開組女單 共30籤

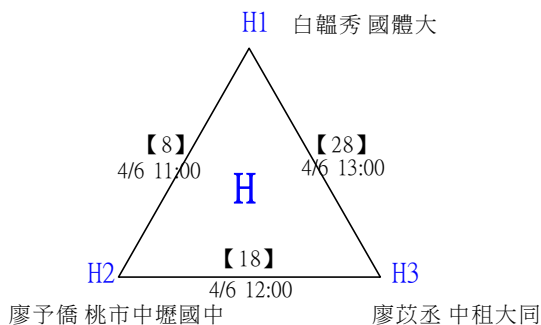
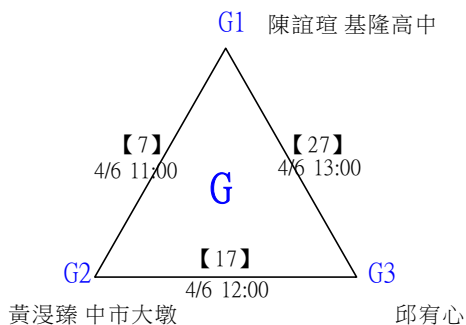
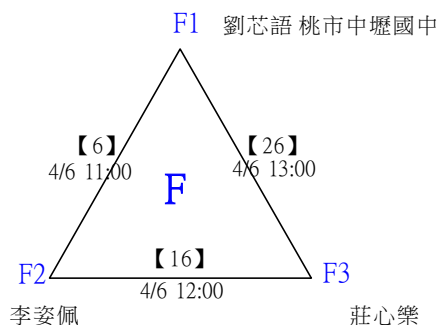
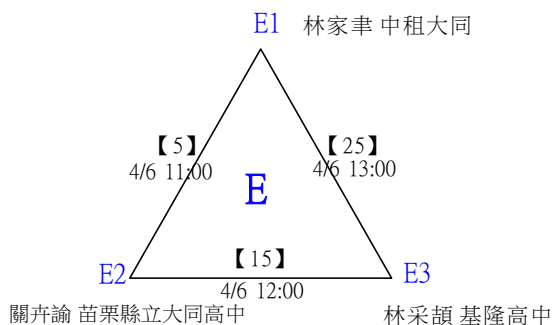
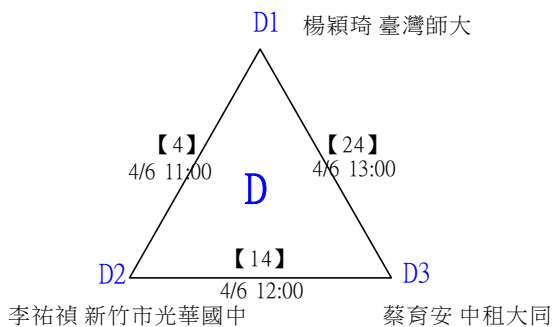
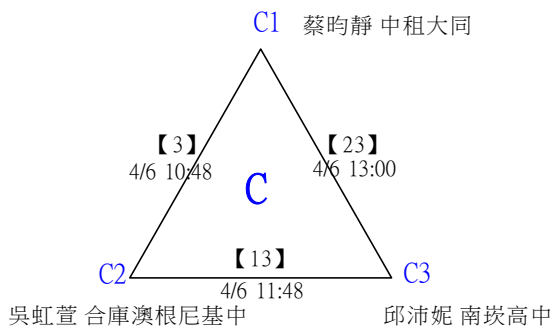
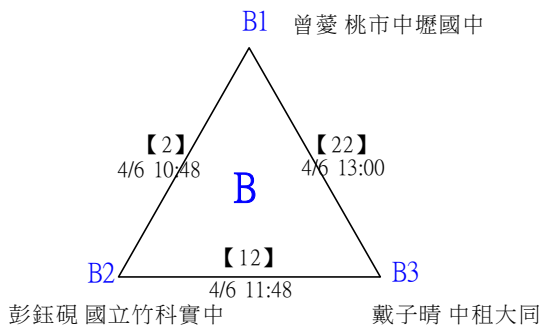
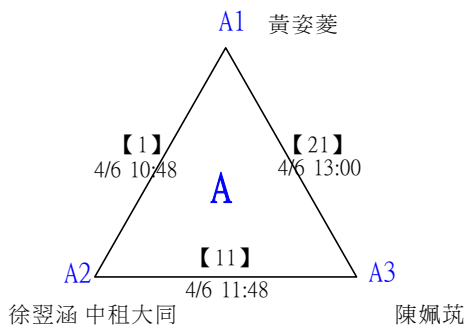

2025富宇建設DEFI羽球錦標賽

取8名

公開組女單 共30籤

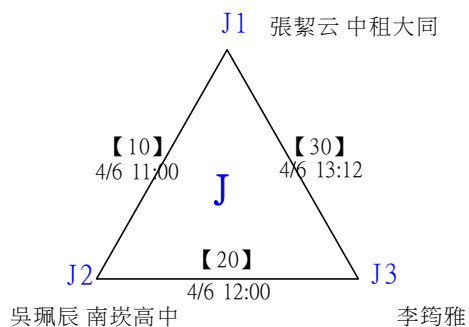
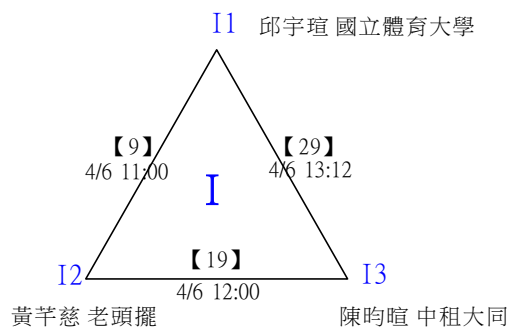

2025富宇建設DEFI羽球錦標賽

取8名

公開組女單

決賽：三角取一，抽籤決定位置。

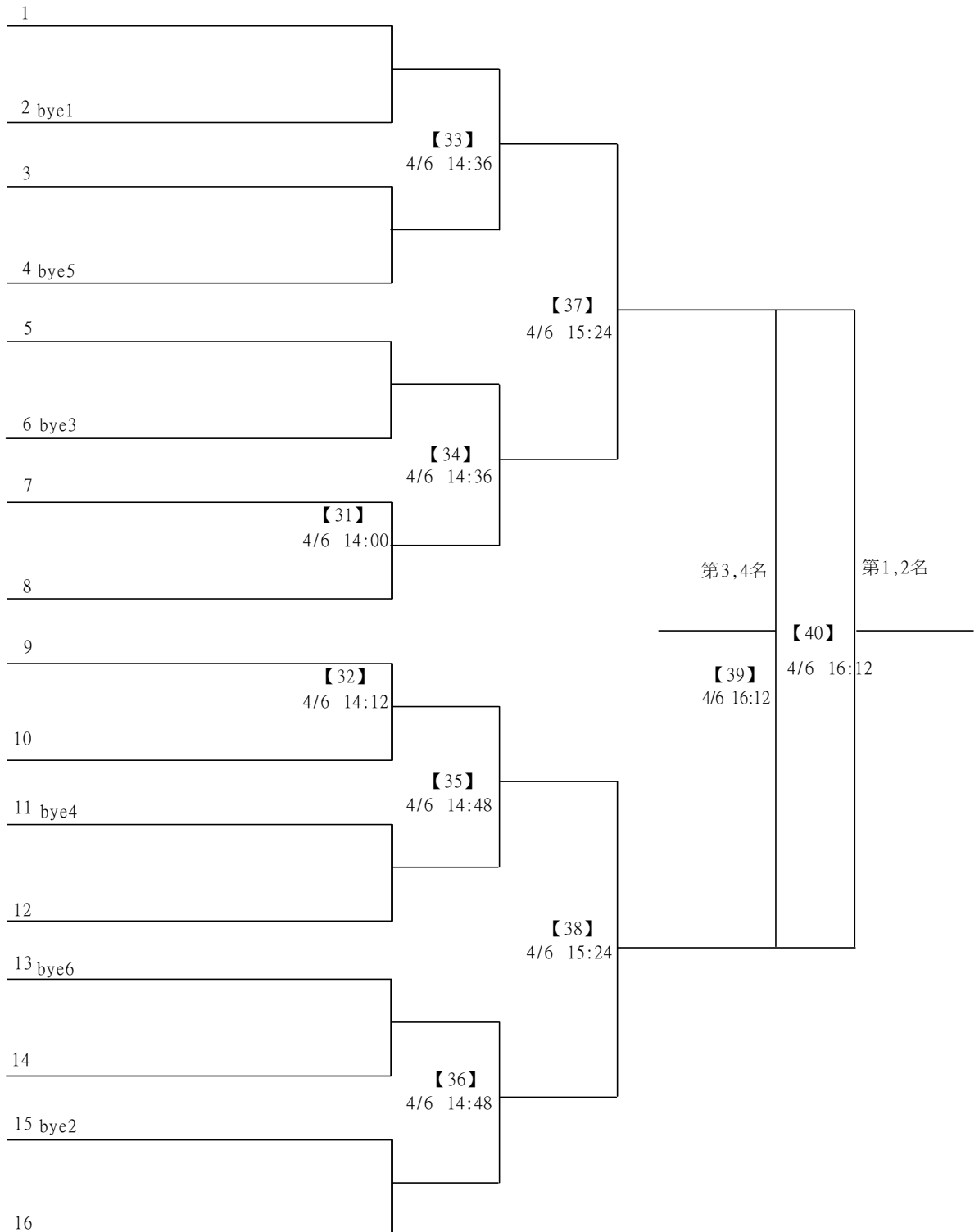

2025富宇建設DEFI羽球錦標賽

取8名

公開組男單 共64籤

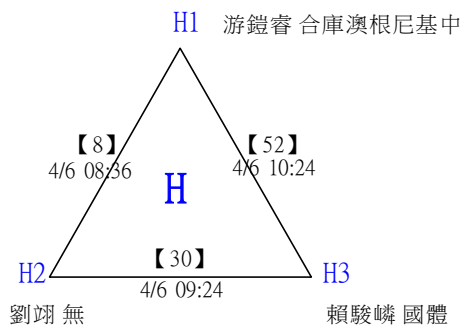
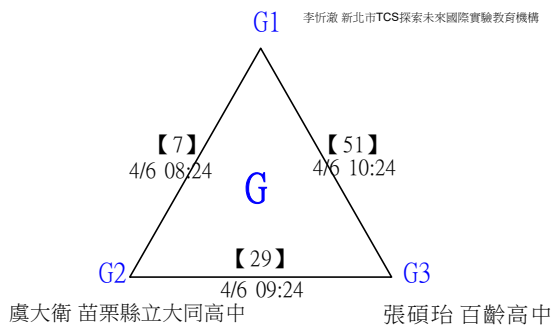
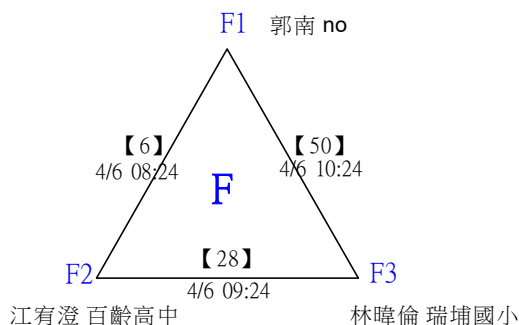
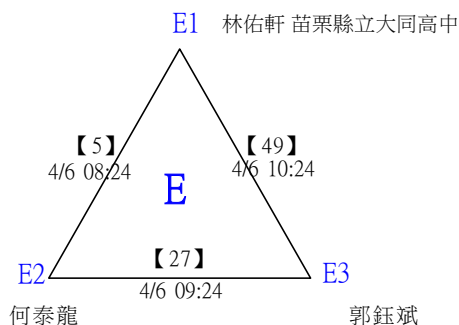
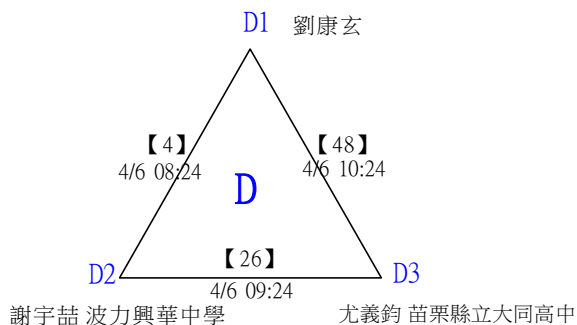
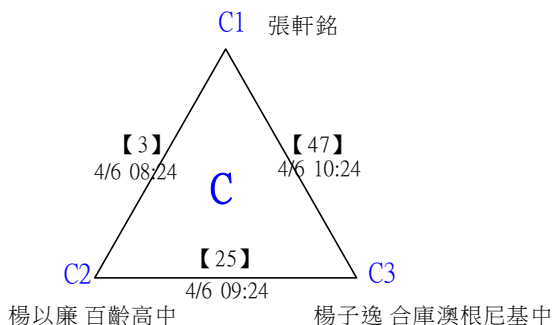
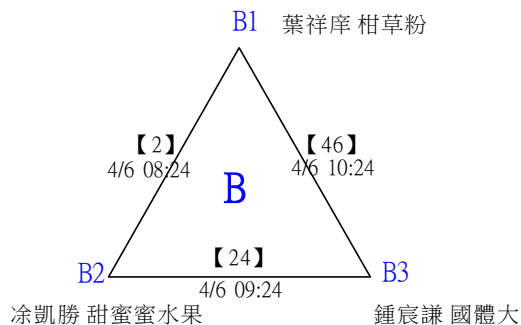
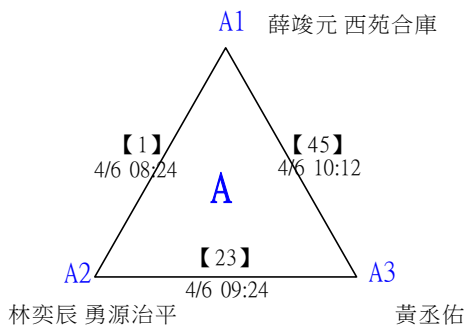

2025富宇建設DEFI羽球錦標賽

取8名

公開組男單 共64籤

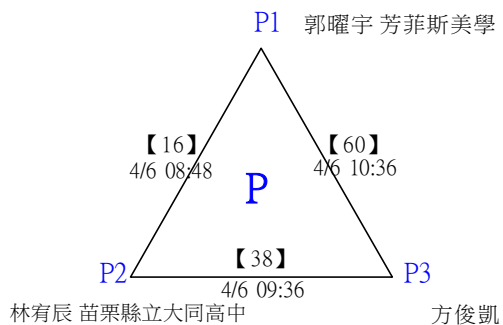
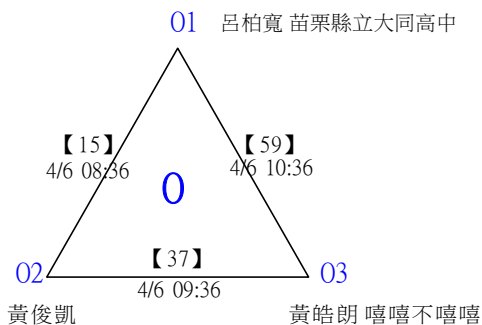
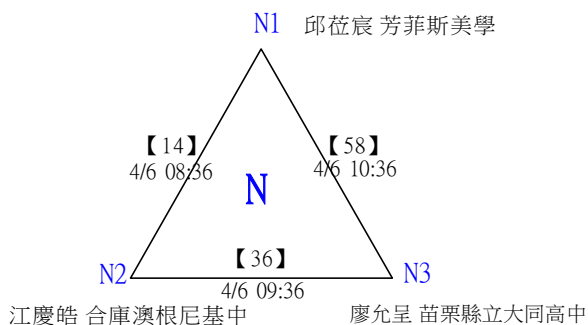
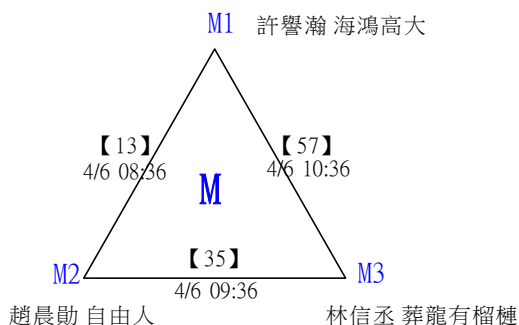
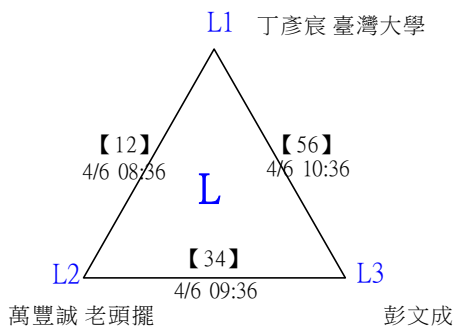
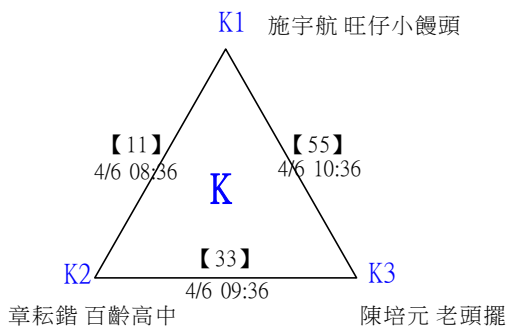
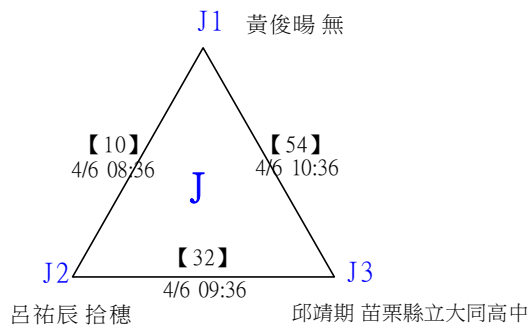
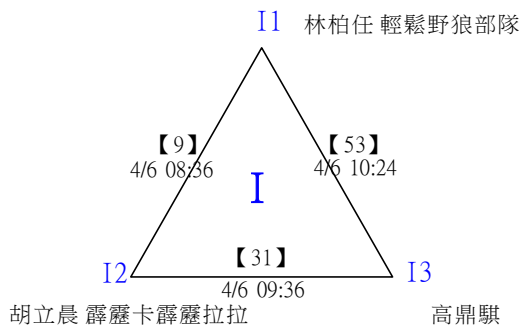

2025富宇建設DEFI羽球錦標賽

取8名

公開組男單 共64籤

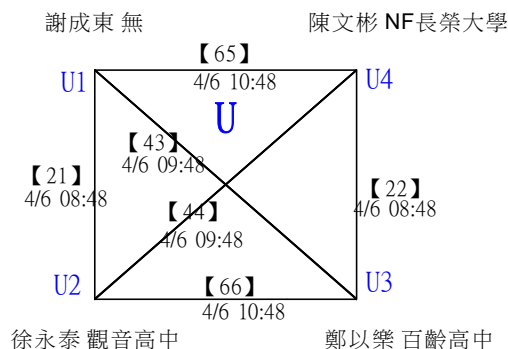
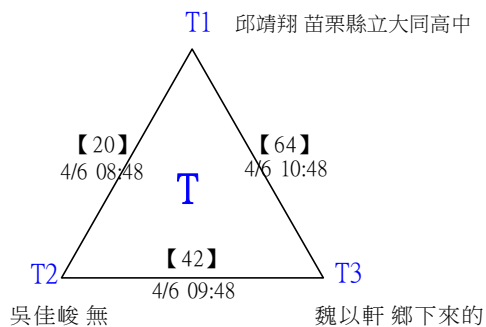
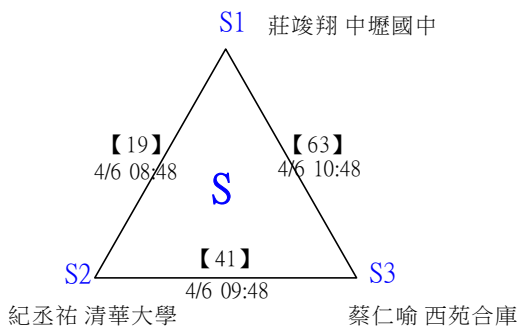
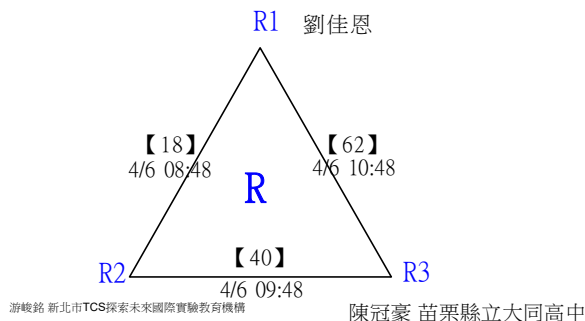
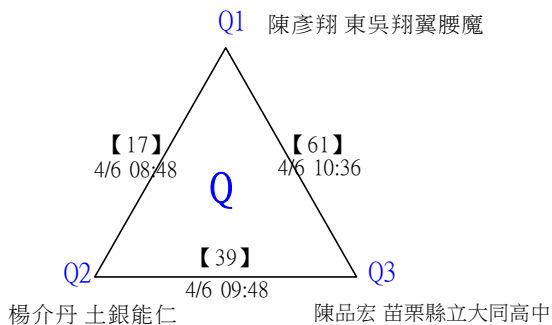

2025富宇建設DEFI羽球錦標賽

取8名

公開組男單

決賽：三角取一，四角取二，抽籤決定位置。

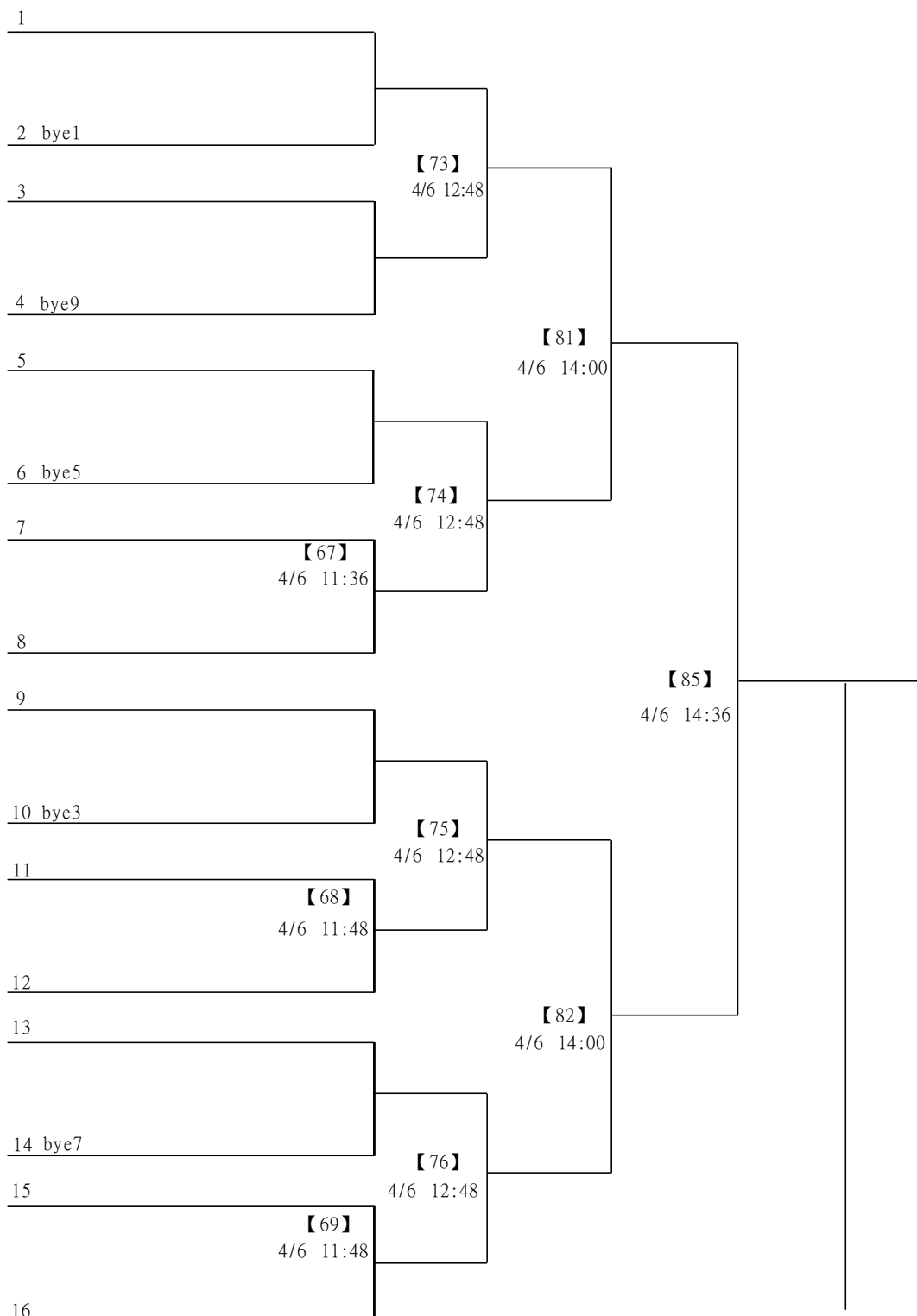

2025富宇建設DEFI羽球錦標賽

取8名

公開組男單

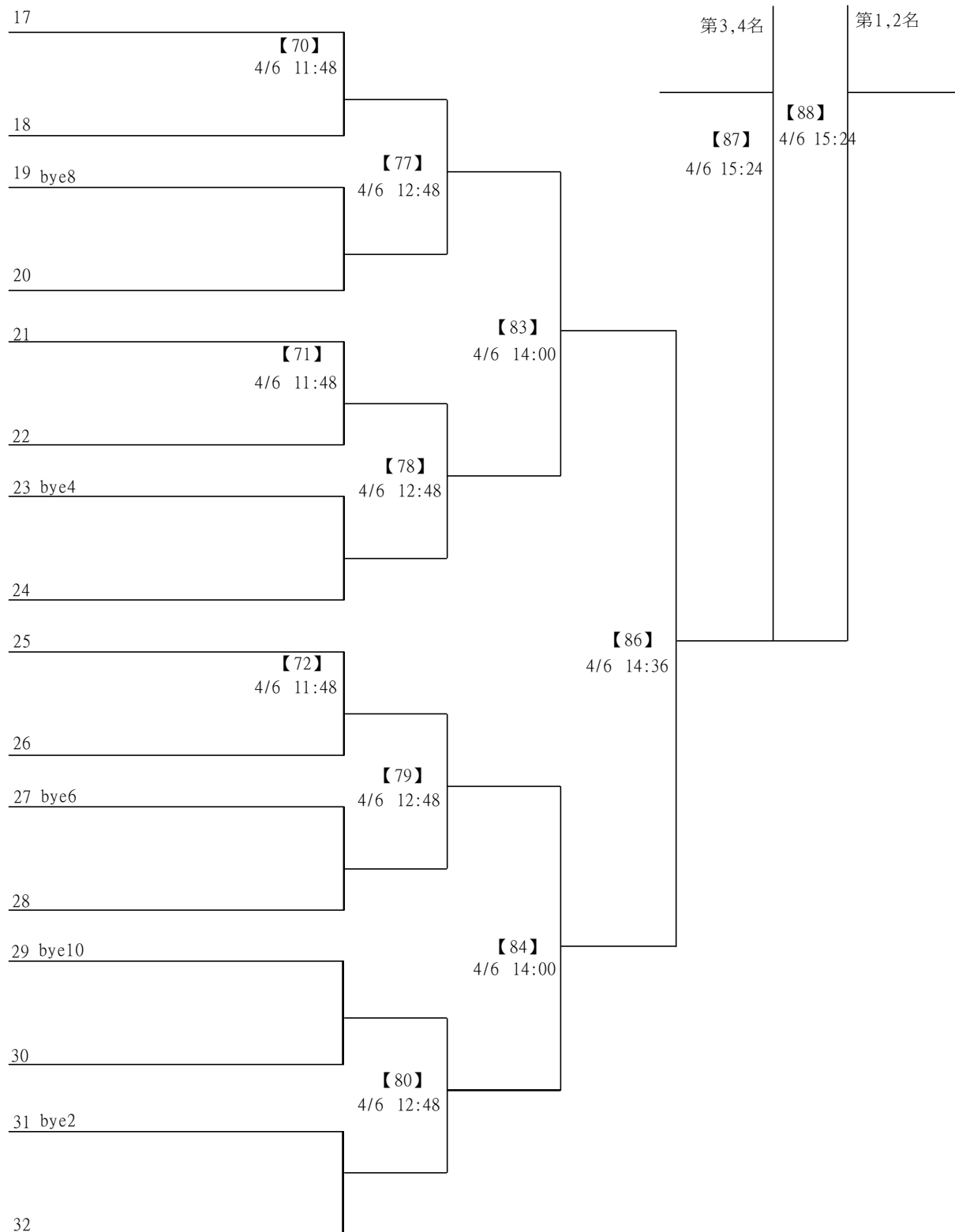

2025富宇建設DEFI羽球錦標賽

國小中年級組女雙 共6籤

取3名

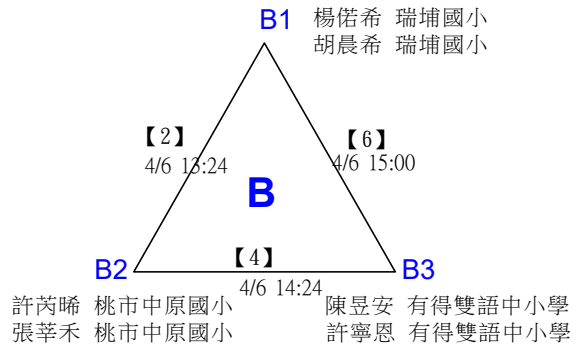
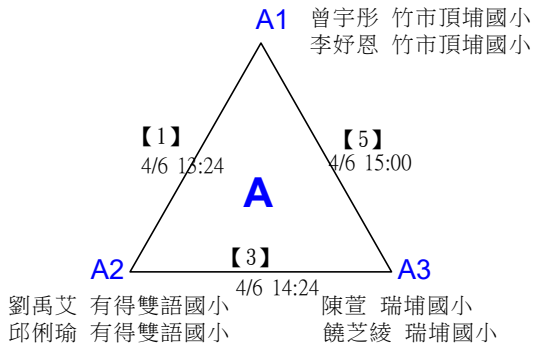

2025富宇建設DEFI羽球錦標賽

國小中年級組女雙

取3名

決賽：分組取二，直接帶入。

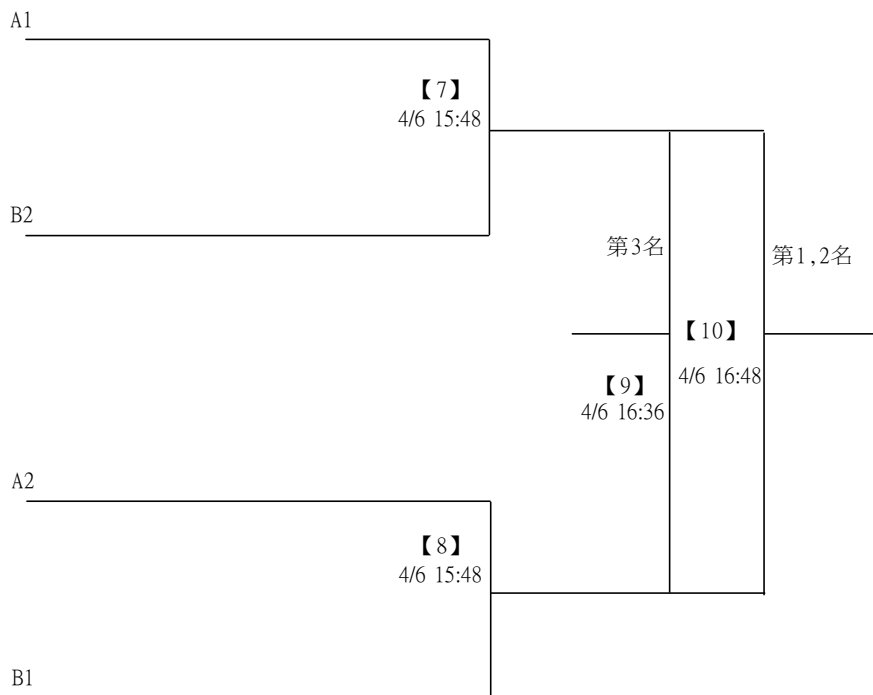

2025富宇建設DEFI羽球錦標賽

取8名

國小中年級組男雙 共29籤

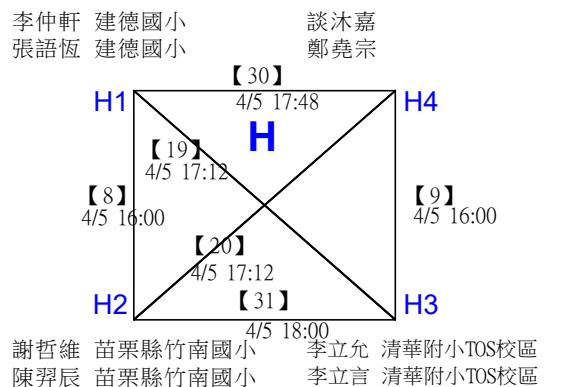
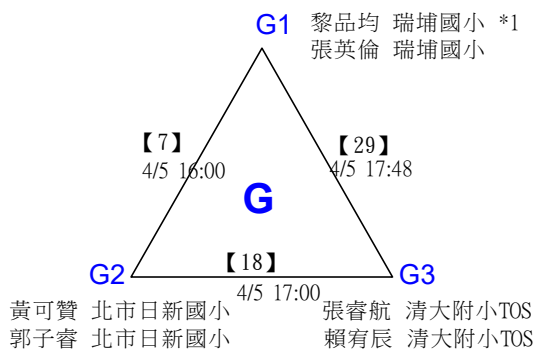
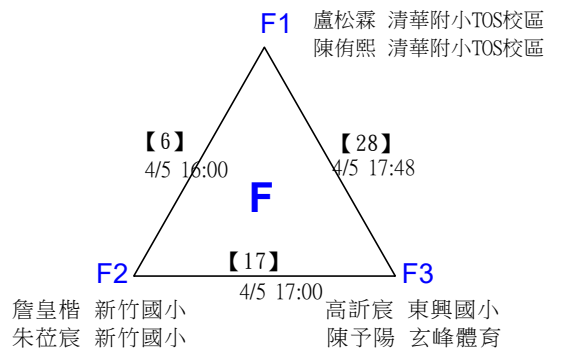
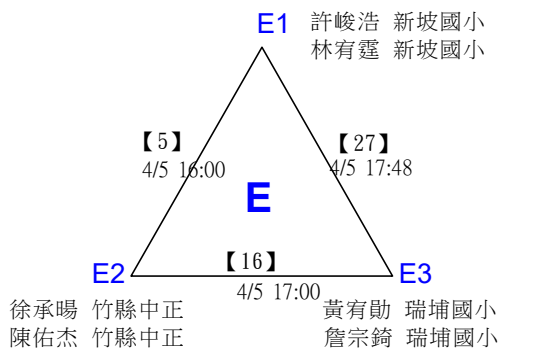
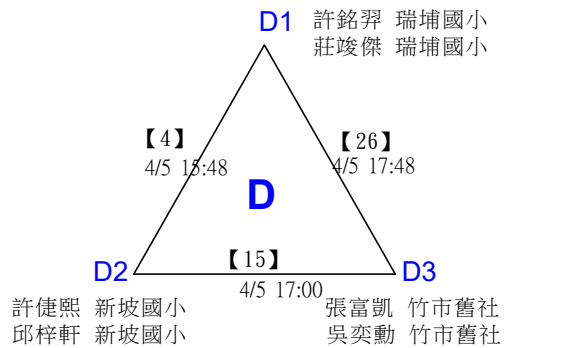
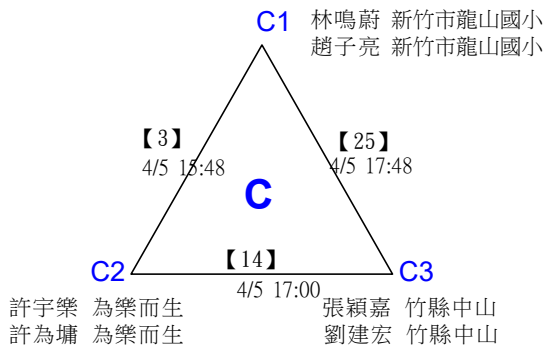
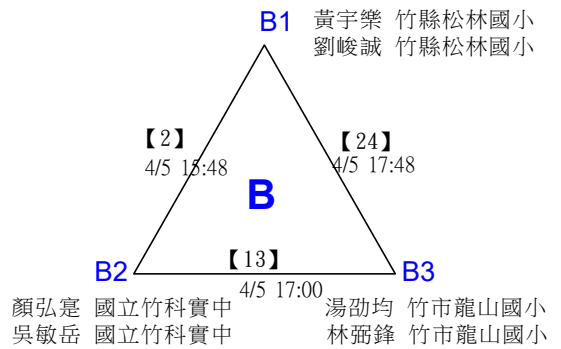
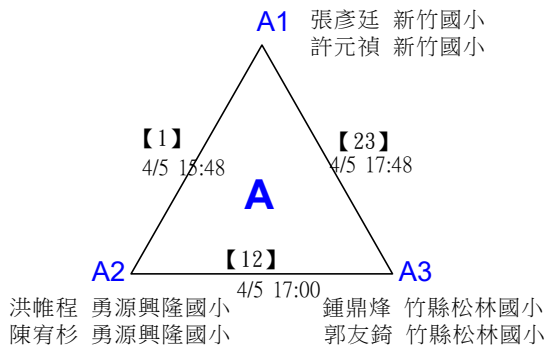

2025富宇建設DEFI羽球錦標賽

國小中年級組男雙 共29籤

取8名

王劭瑜 康乃薈雙語中小學 白仲輔 勇源興隆國小
 何亦陽 康乃薈雙語中小學 陳禹安 勇源興隆國小

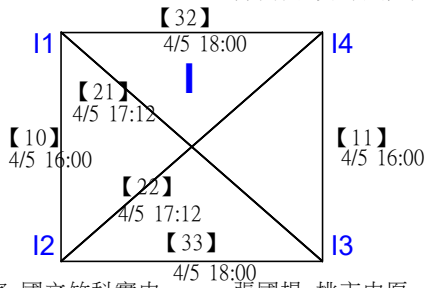

黃梓家 國立竹科實中 張國揚 桃市中原
 呂循崐 國立竹科實中 張軒睿 桃市中原

2025富宇建設DEFI羽球錦標賽

取8名

國小中年級組男雙

決賽：三角取一，四角取二，抽籤決定位置。

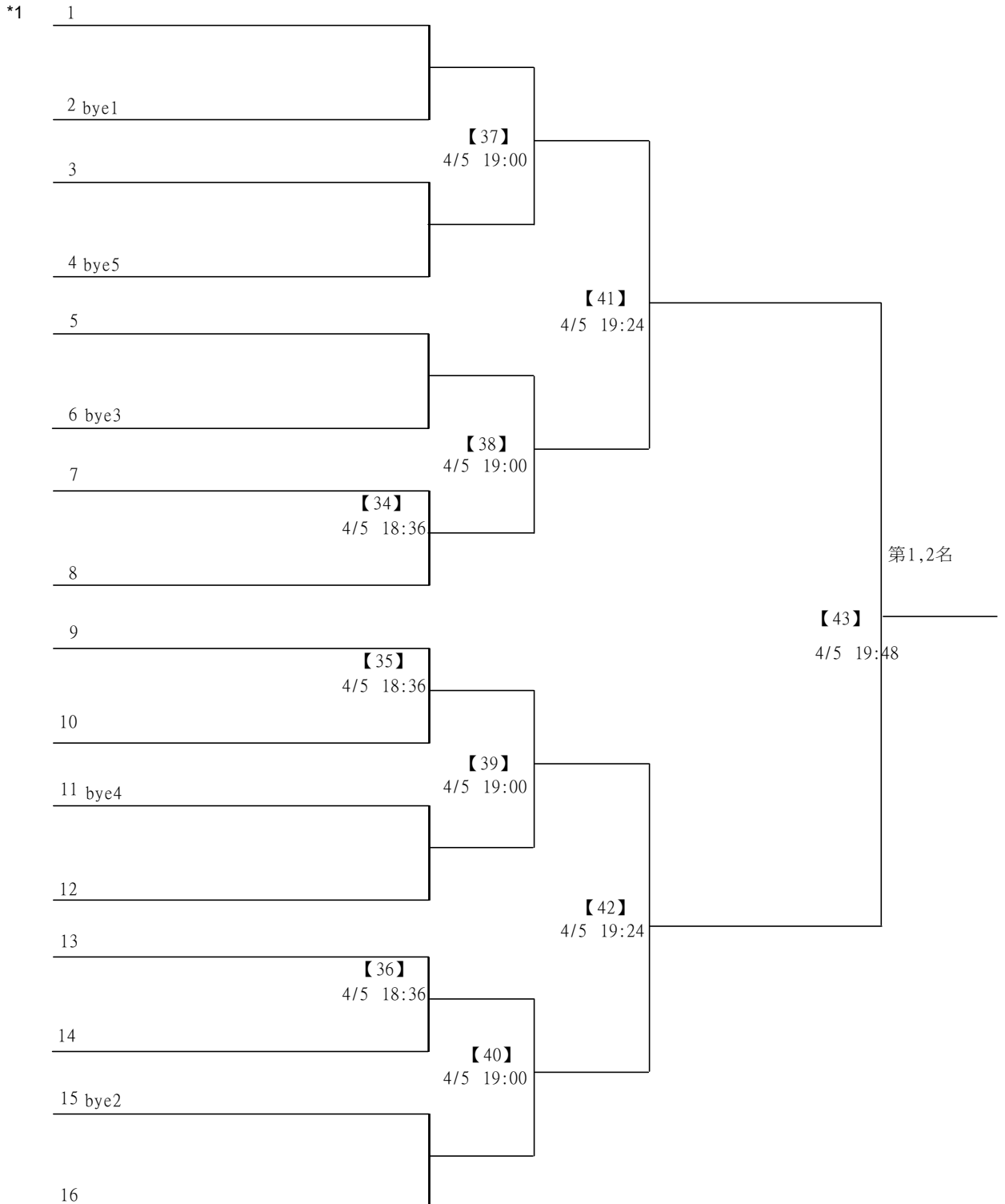

2025富宇建設DEFI羽球錦標賽

國小高年級組女雙 共8籤

取4名

楊媿安 瑞埔國小 *1 洪立昶 載熙國小
 饒若琪 瑞埔國小 陳柔方 舊社國小

柯思樺 竹市東園 詹駿瑜 勇源興隆國小
 柳宣彩 國立竹科實中 姚采蓮 勇源興隆國小

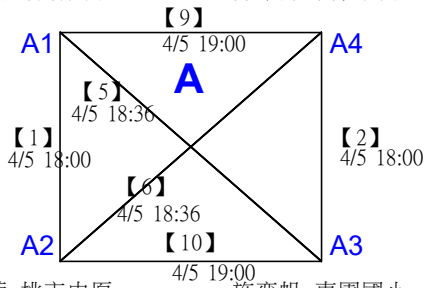

吳岱蓉 桃市中原 施奕帆 東園國小
 余虹誼 桃市中原 賴采昀 東園國小

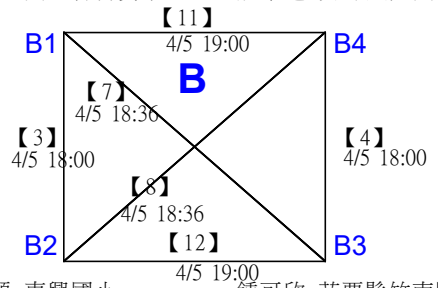

林子願 東興國小 鍾可欣 苗栗縣竹南國小
 李卉筠 東興國小 楊千好 苗栗縣竹南國小

2025富宇建設DEFI羽球錦標賽

國小高年級組女雙

取4名

決賽：分組取二，直接帶入。

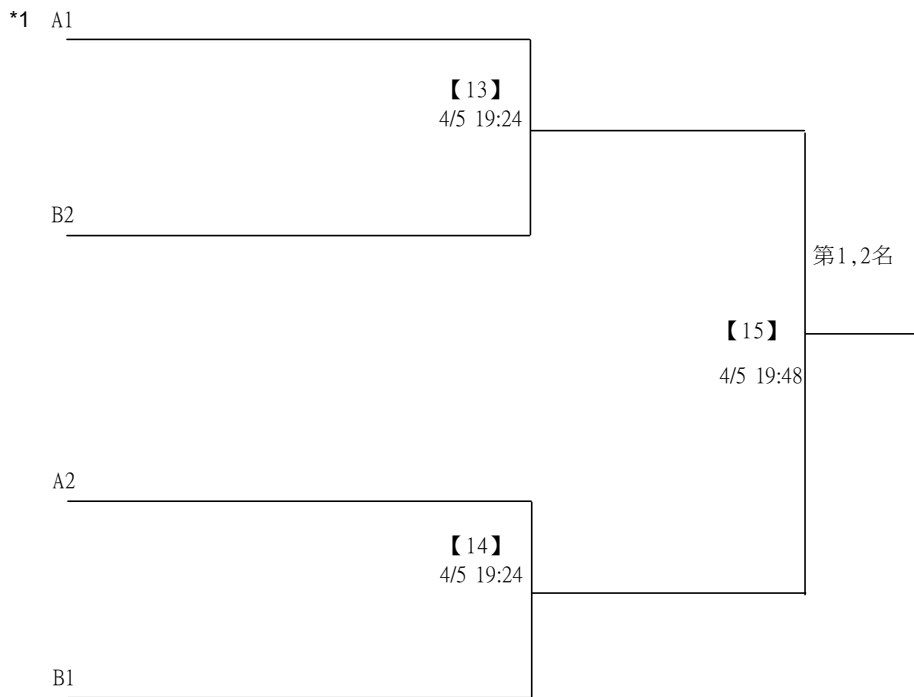

2025 富宇建設DEFI羽球錦標賽

取8名

國小高年級組男雙 共27籤

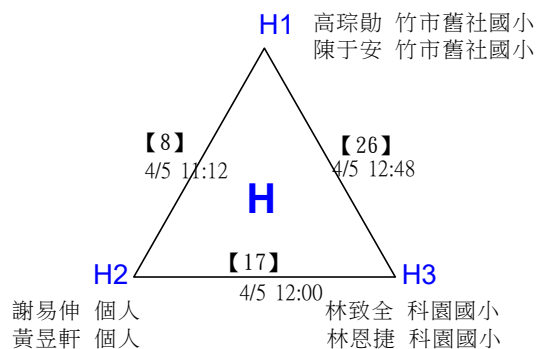
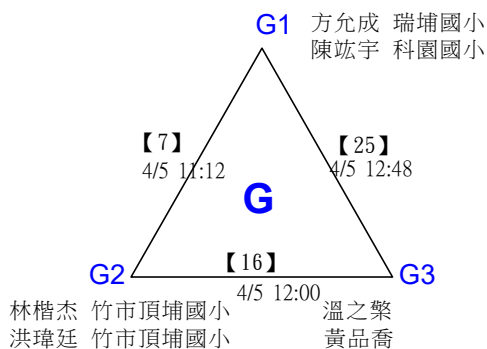
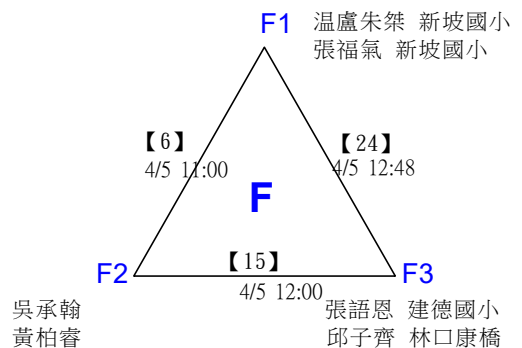
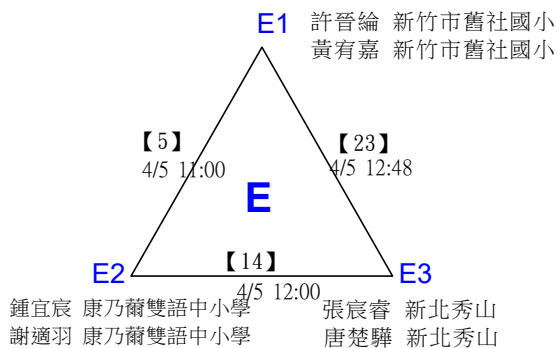
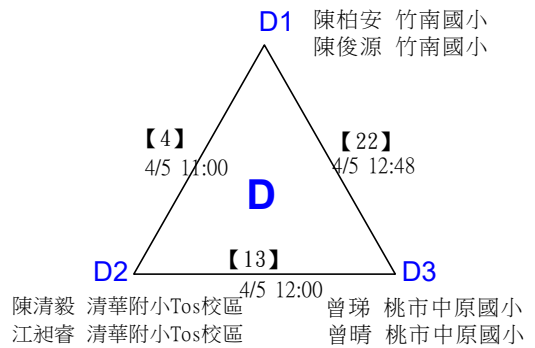
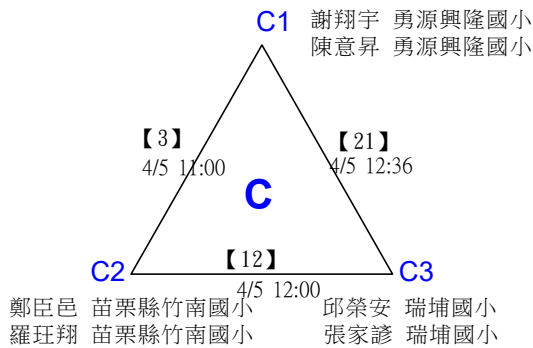
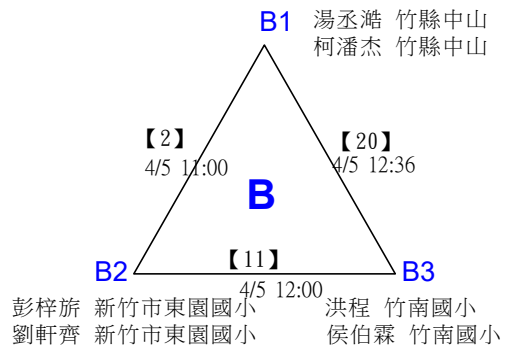
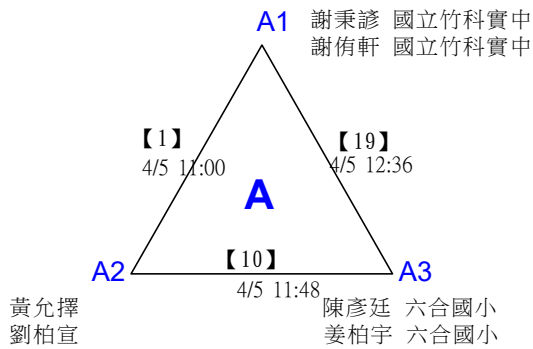

2025富宇建設DEFI羽球錦標賽

取8名

國小高年級組男雙 共27籤

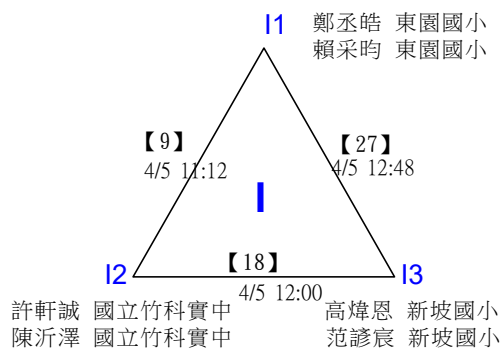

2025富宇建設DEFI羽球錦標賽

取8名

國小高年級組男雙

決賽：三角取一，抽籤決定位置。

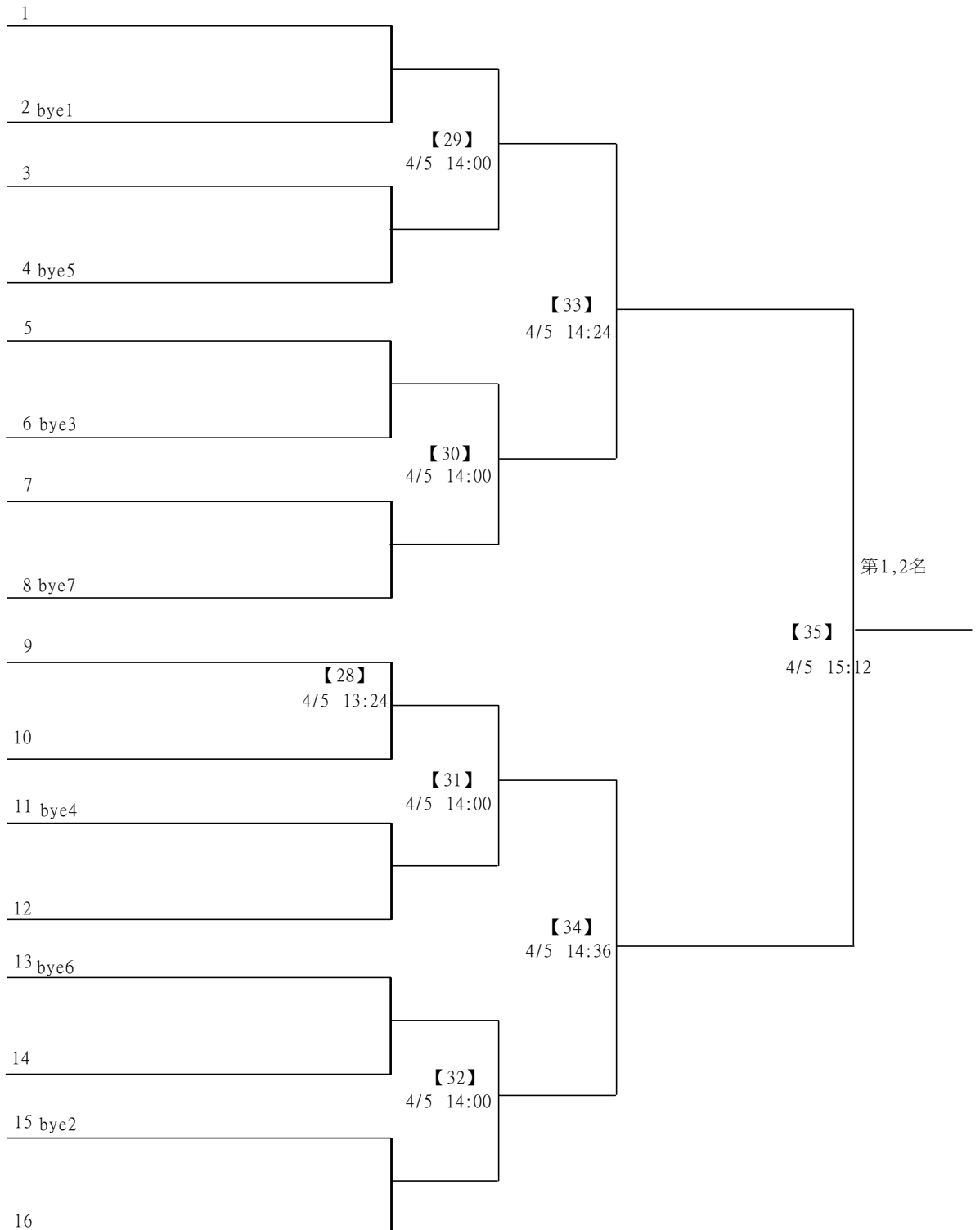

2025 富宇建設DEFI羽球錦標賽

取8名

國小親子組雙打 共32籤

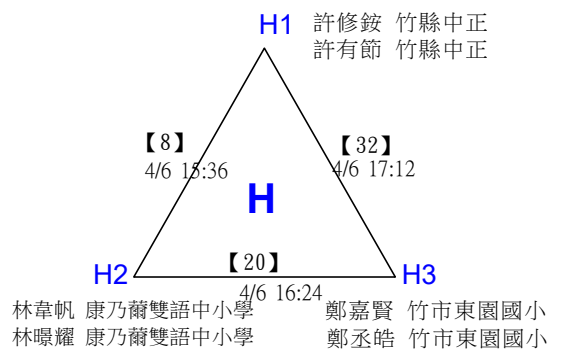
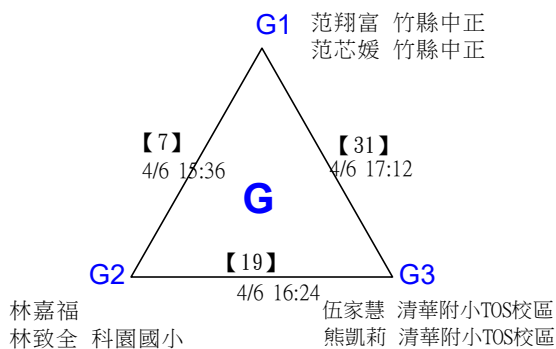
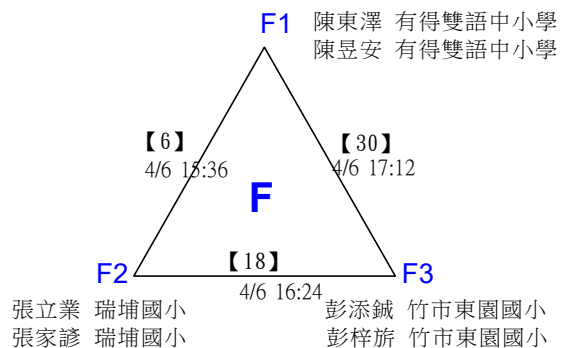
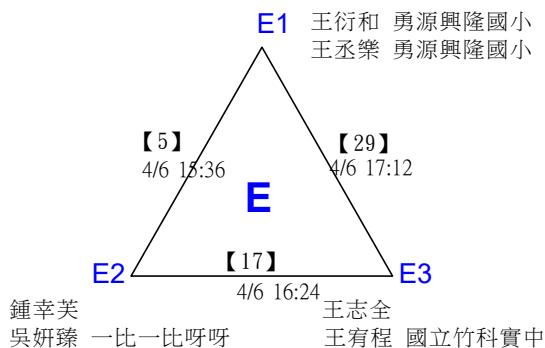
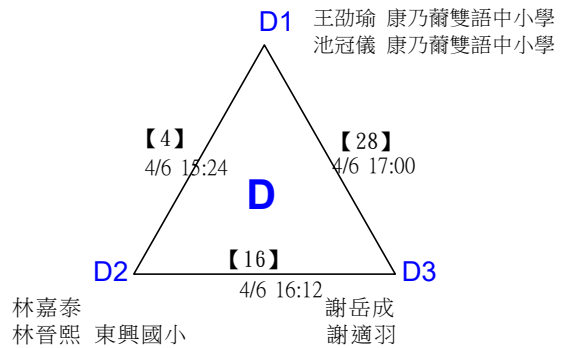
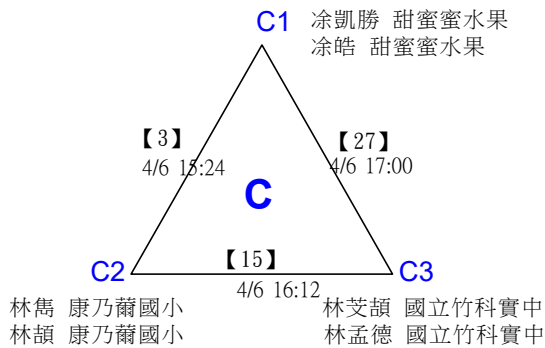
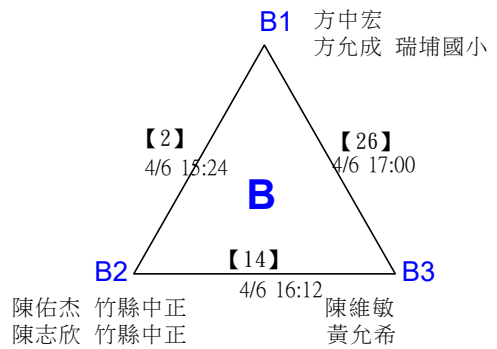
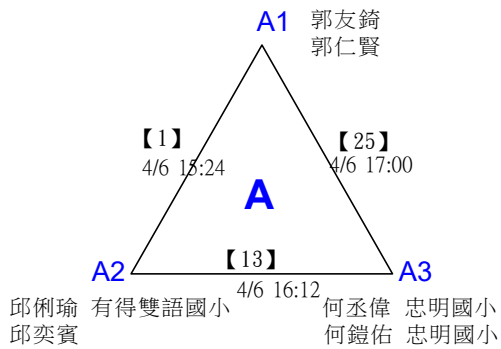

2025富宇建設DEFI羽球錦標賽

取8名

國小親子組雙打 共32籤

莊楚健 黃志韡 黃富新
莊竣傑 瑞埔國小 黃楹閑 黃富新

邱子齊 林口康橋 黃煒鈞 NEWS Family
邱永生 林口康橋 黃子恩 NEWS Family

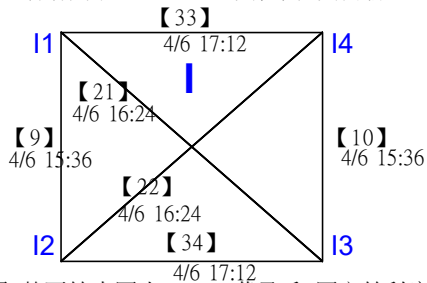

陳柏闓 苗栗竹南國小 黃丞禾 國立竹科實中
陳金龍 苗栗竹南國小 黃烽煉 國立竹科實中

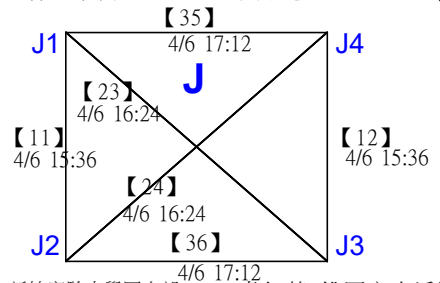

林芸安 新竹實驗中學國小部 盧仁茂 桃園市大溪國中
林嘉仁 新竹實驗中學國小部 盧依辰 桃園市仁和國小

2025富宇建設DEFI羽球錦標賽

取8名

國小親子組雙打

決賽：三角取一，四角取二，抽籤決定位置。

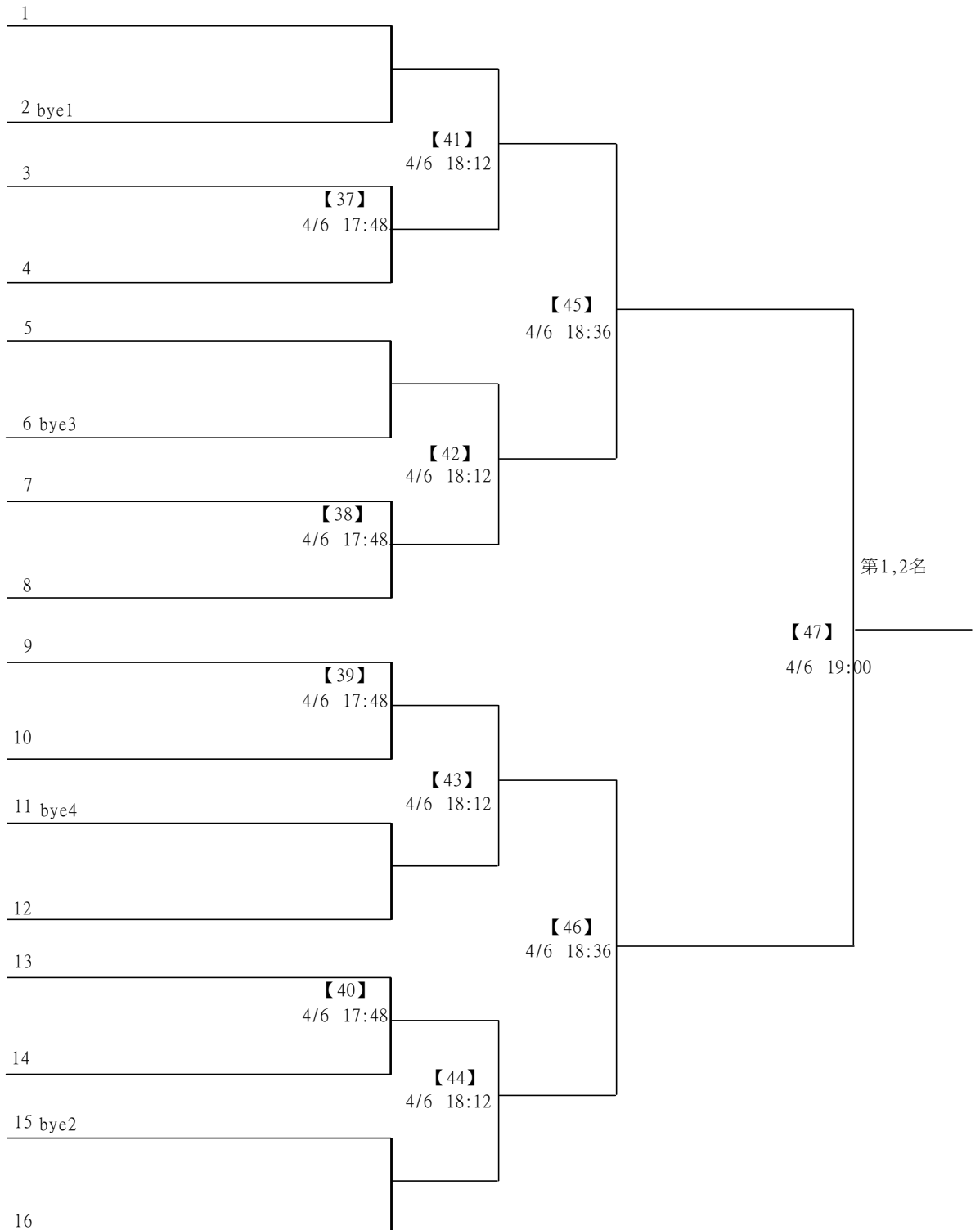

2025富宇建設DEFI羽球錦標賽

取3名

國中親子組雙打 共6籤

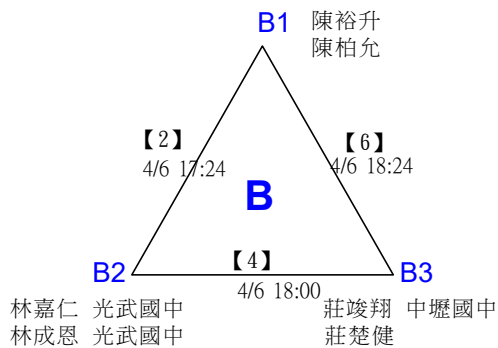
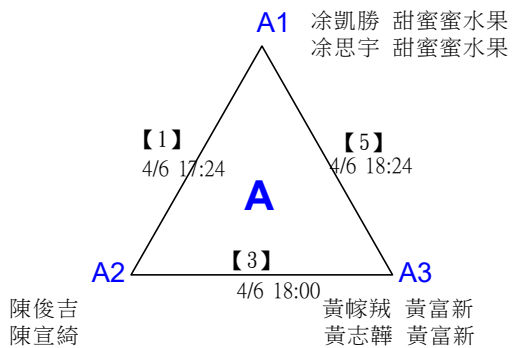

2025富宇建設DEFI羽球錦標賽

國中親子組雙打

取3名

決賽：分組取二，直接帶入。

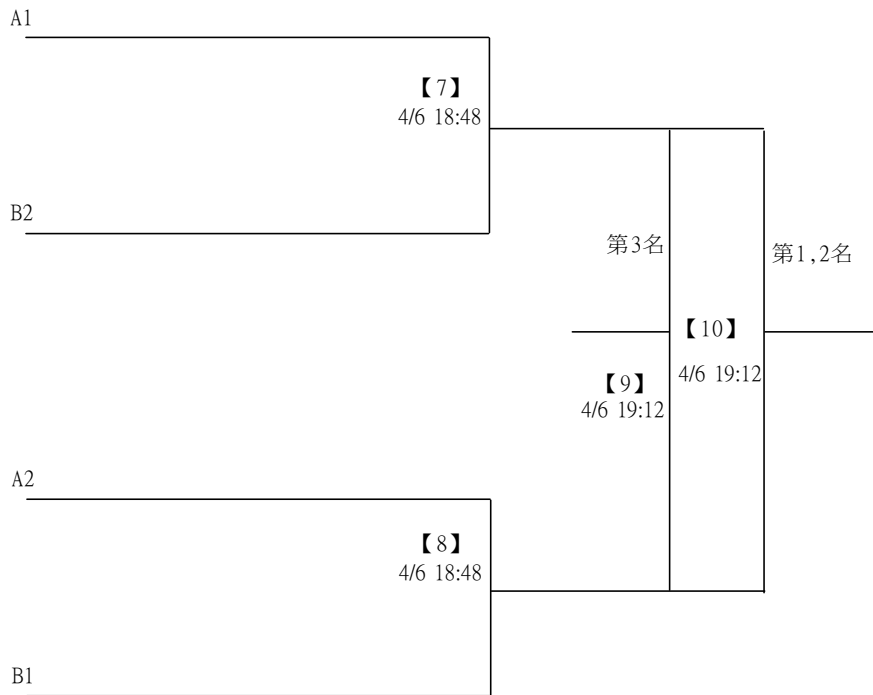

2025富宇建設DEFI羽球錦標賽

取3名

30歲以下組女雙 共23籤

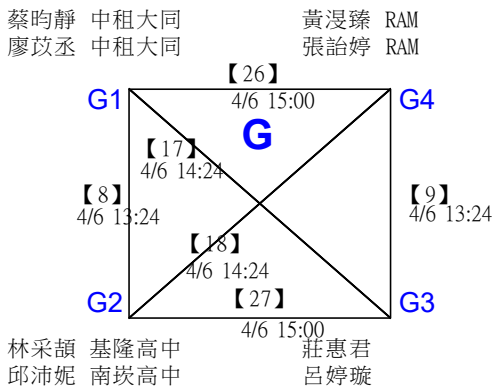
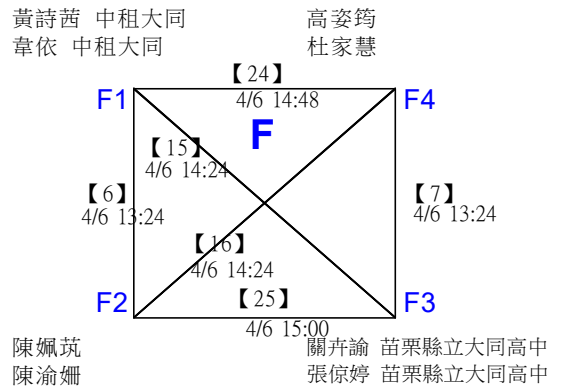
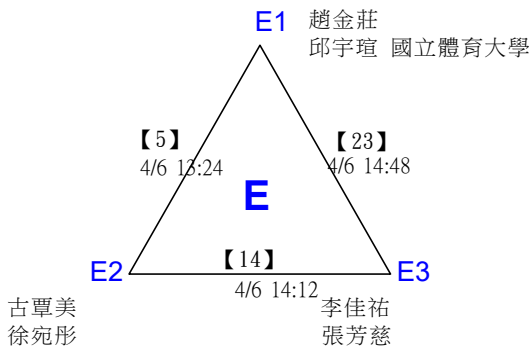
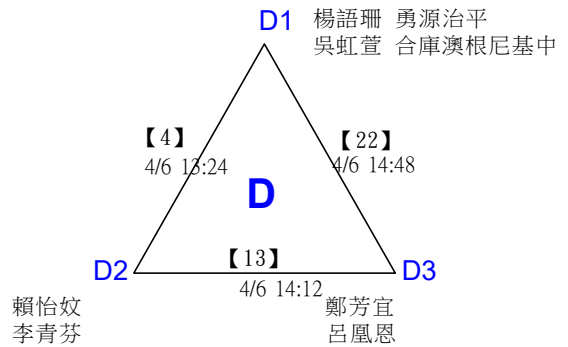
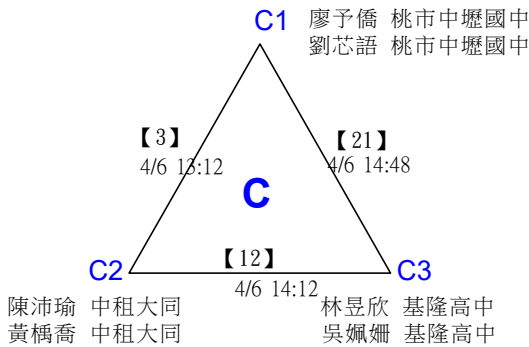
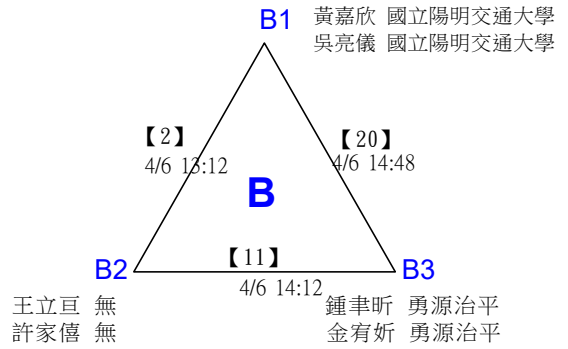
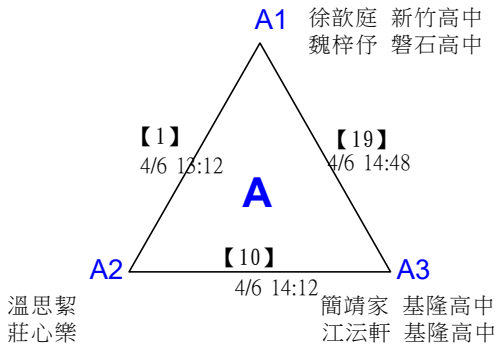

2025富宇建設DEFI羽球錦標賽

取3名

30歲以下組女雙

決賽：三角取一，四角取二，抽籤決定位置。

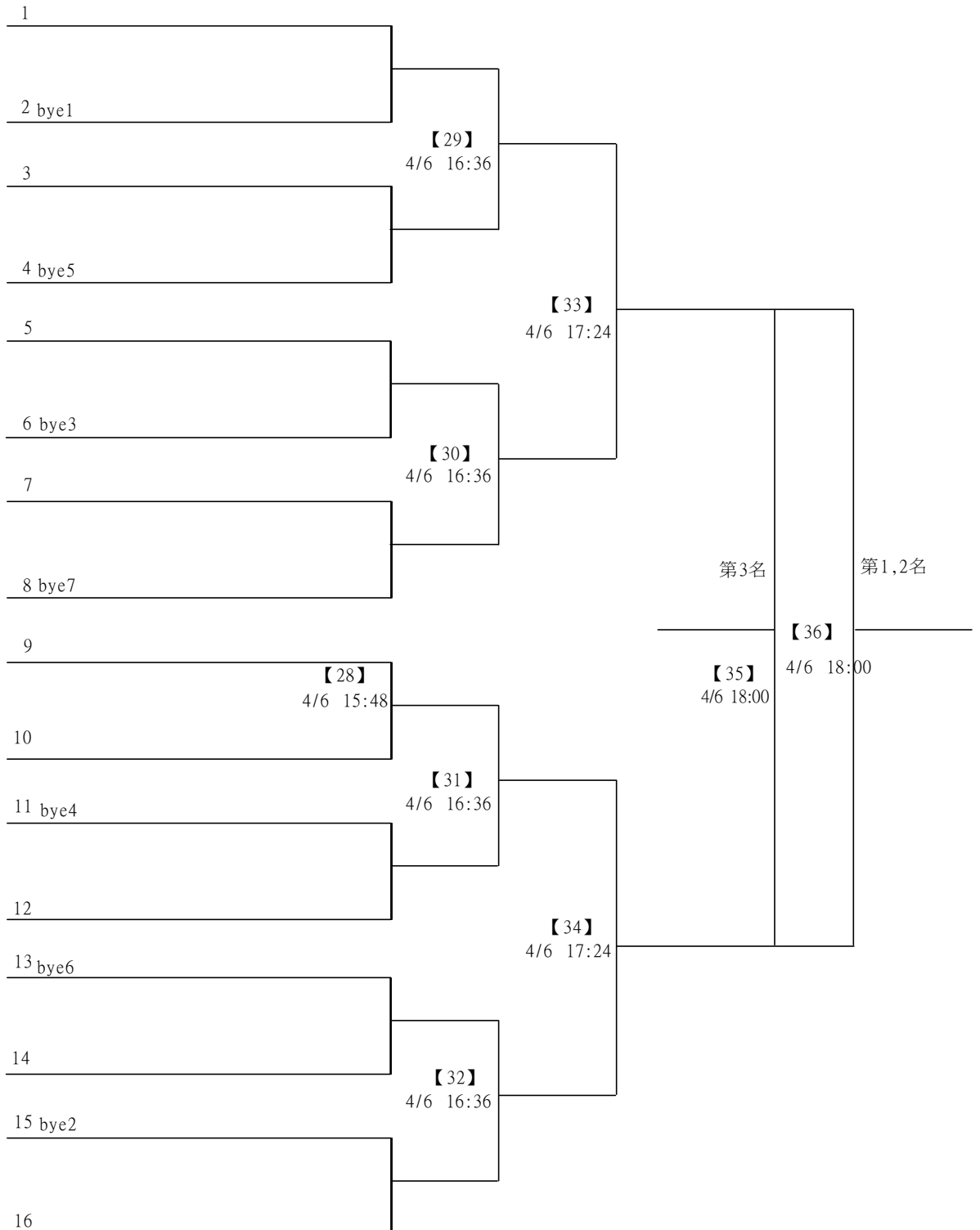

2025富宇建設DEFI羽球錦標賽

取8名

30歲以下組男雙 共53籤

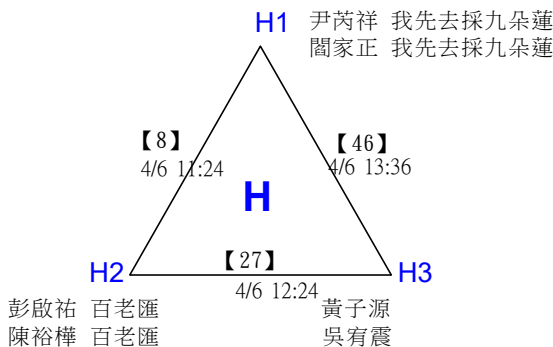
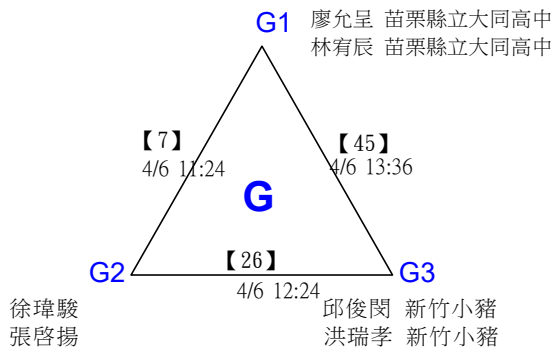
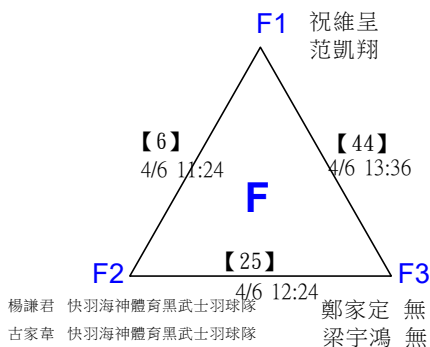
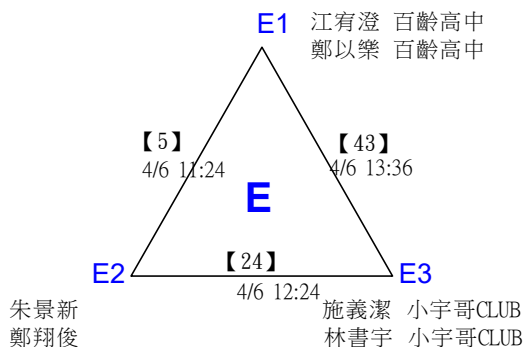
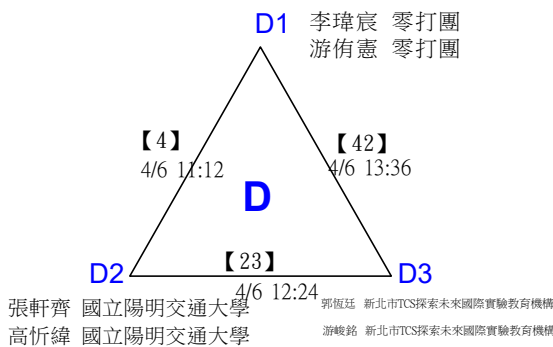
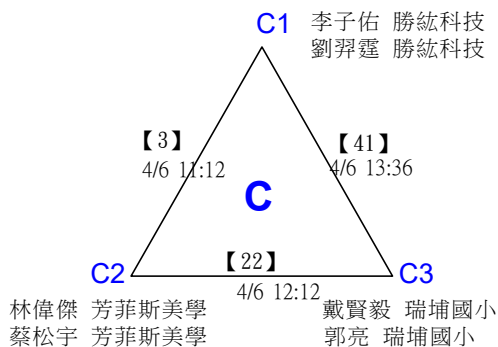
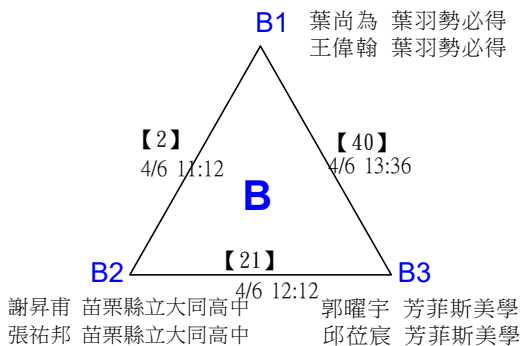
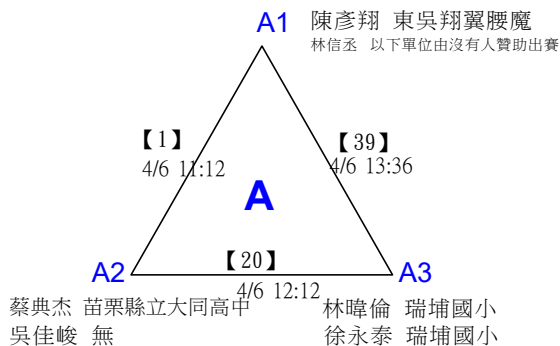

2025富宇建設DEFI羽球錦標賽

取8名

30歲以下組男雙 共53籤

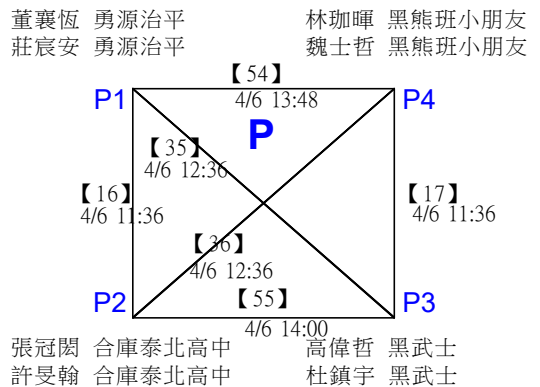
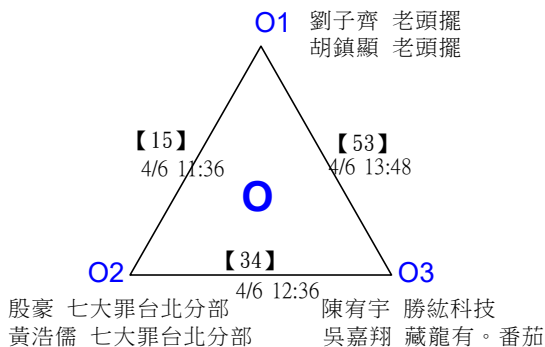
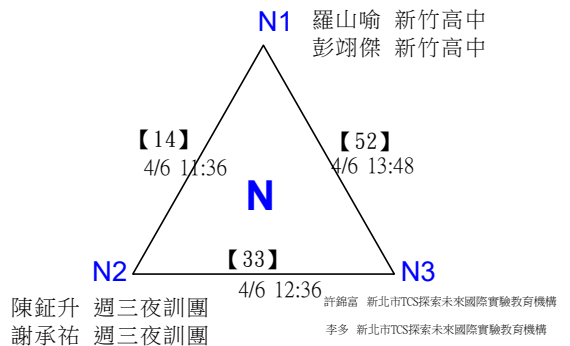
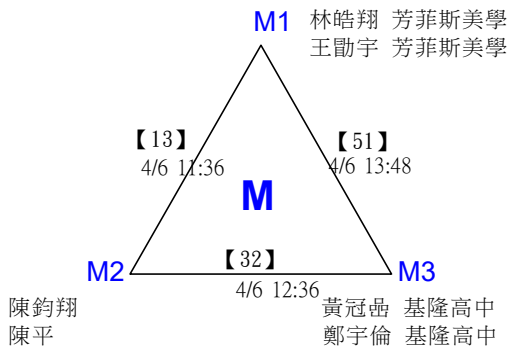
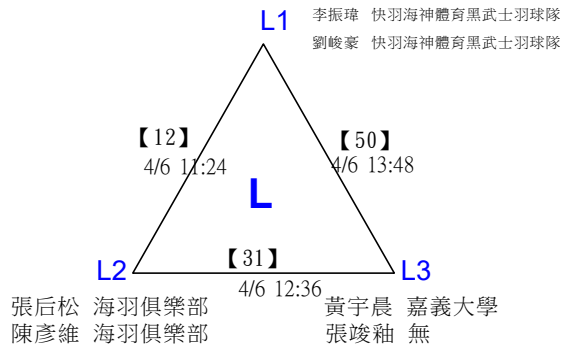
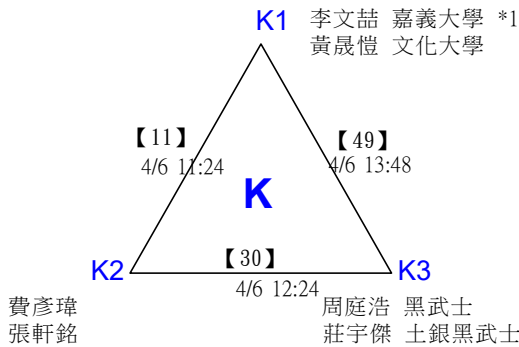
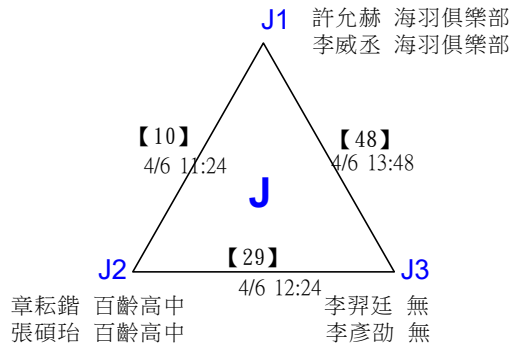
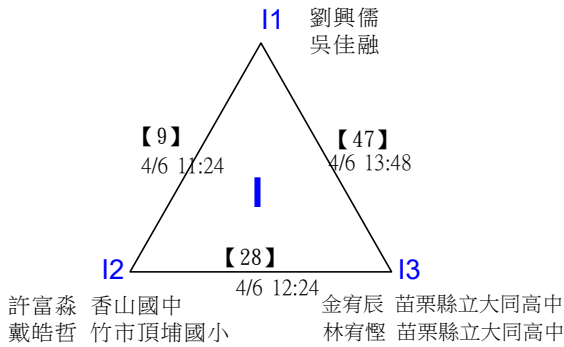

2025富宇建設DEFI羽球錦標賽

30歲以下組男雙 共53籤

取8名

黃志韡 黃富新 徐錫品 RAM
 邱界廷 黃富新 邱子暢 RAM

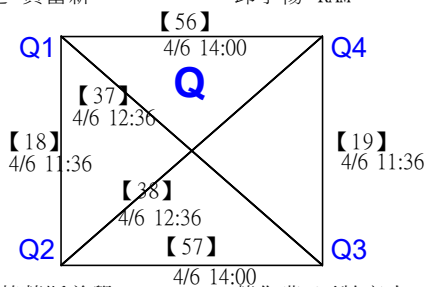

胡義 芳菲斯美學 葉作豐 百齡高中
 邱柏罡 芳菲斯美學 楊以廉 百齡高中

2025富宇建設DEFI羽球錦標賽

取8名

30歲以下組男雙

決賽：三角取一，四角取二，抽籤決定位置。

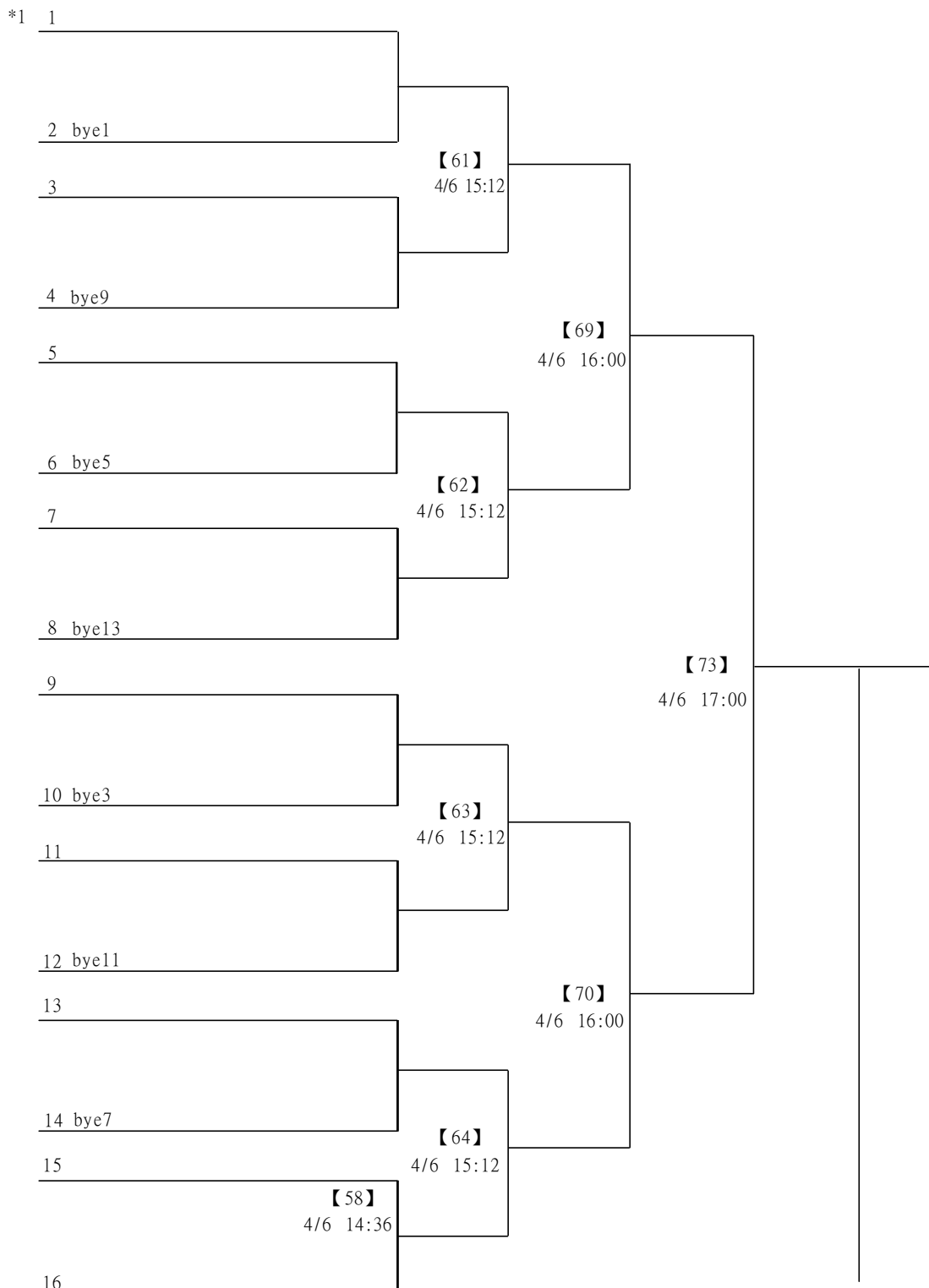

2025富宇建設DEFI羽球錦標賽

取8名

30歲以下組男雙

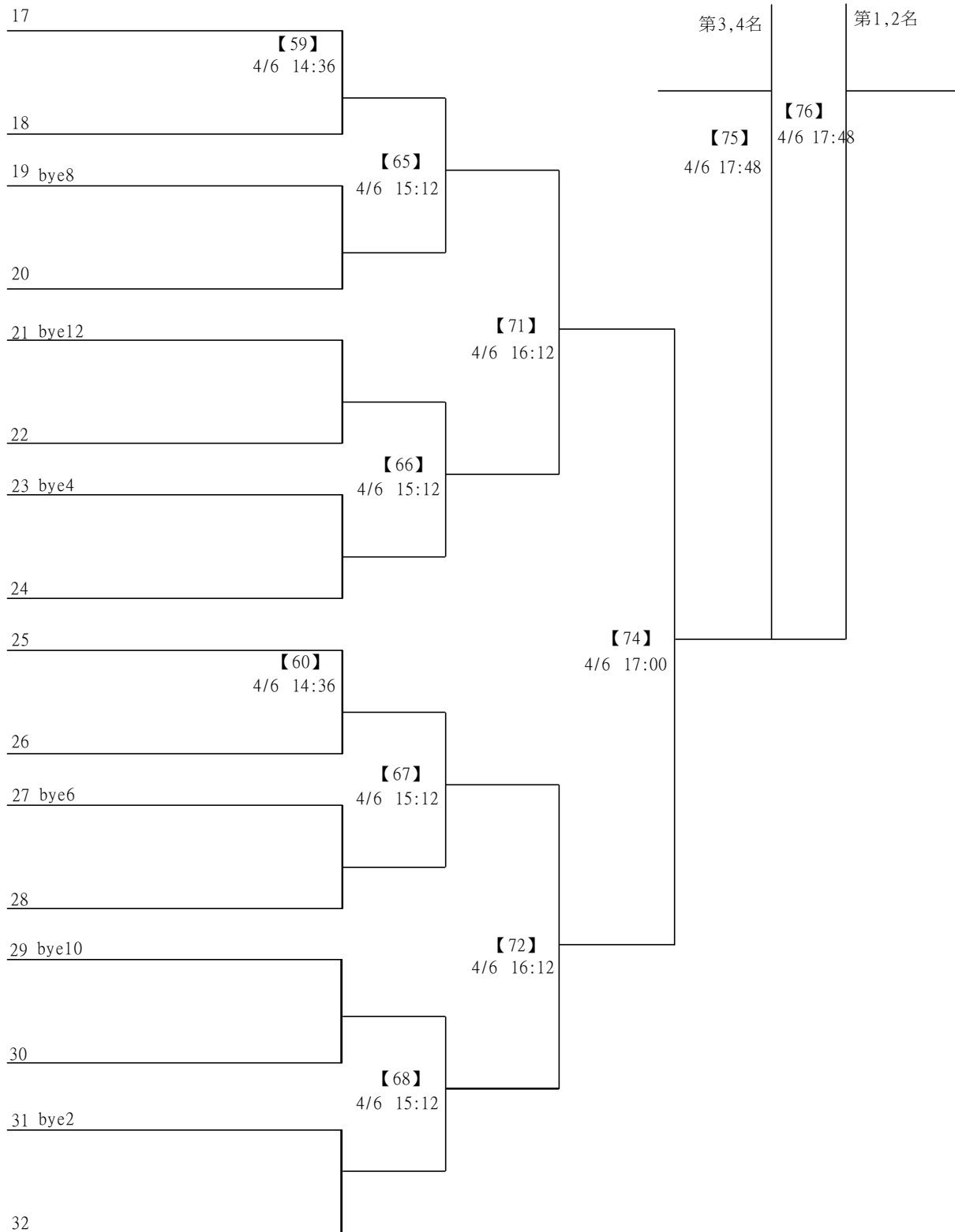

2025 富宇建設DEFI羽球錦標賽

取8名

30歲以下組混雙 共27籤

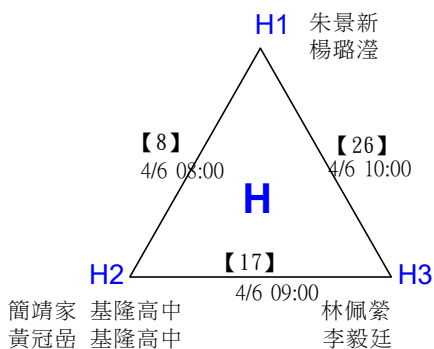
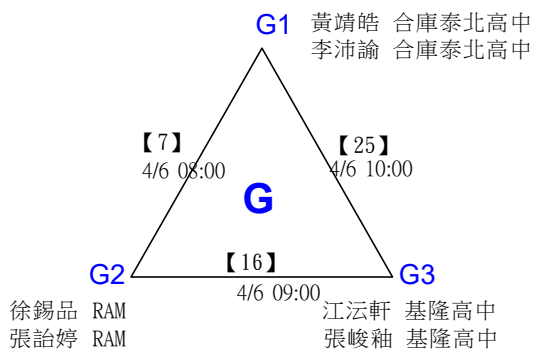
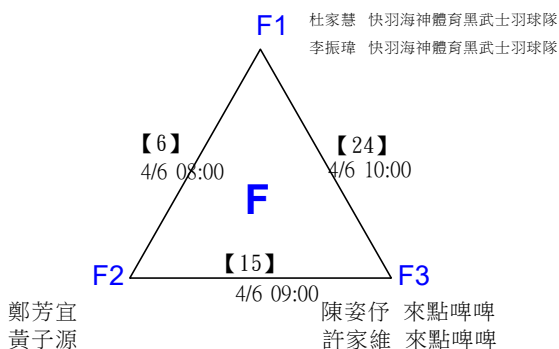
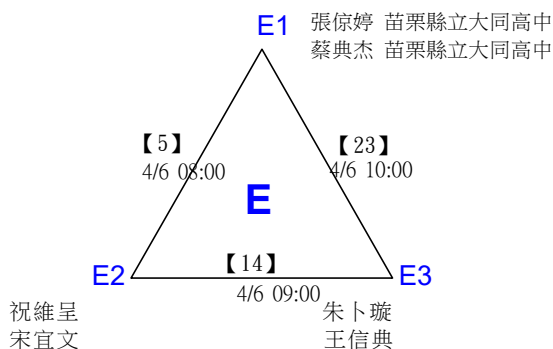
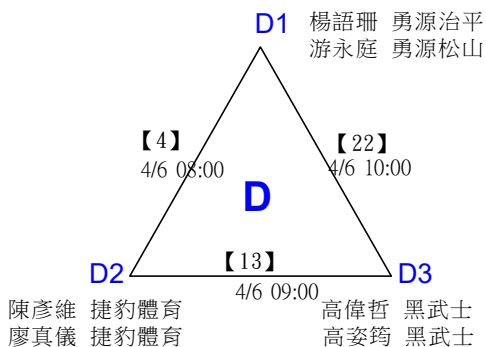
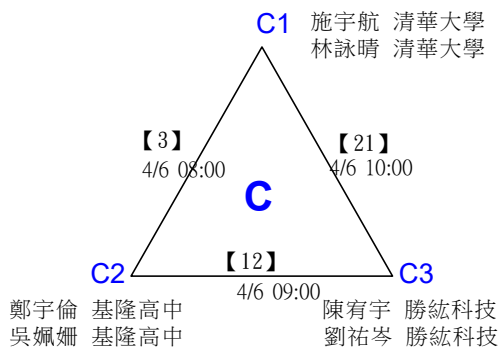
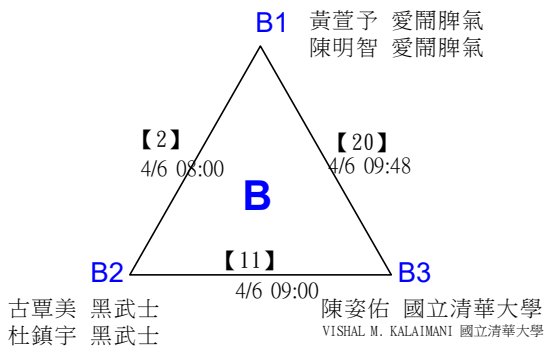
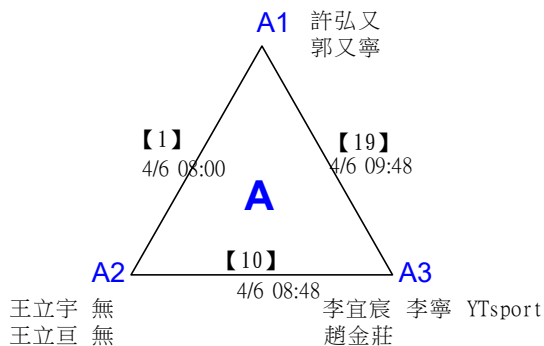

2025富宇建設DEFI羽球錦標賽

取8名

30歲以下組混雙 共27籤

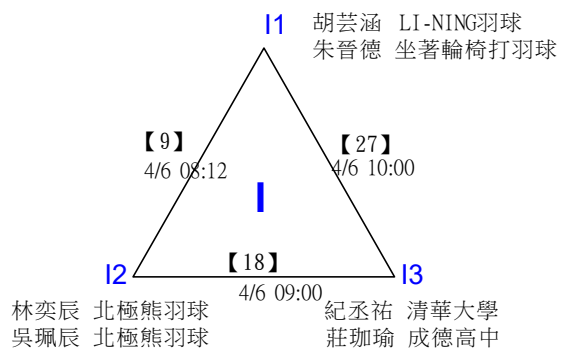

2025富宇建設DEFI羽球錦標賽

取8名

30歲以下組混雙

決賽：三角取一，抽籤決定位置。

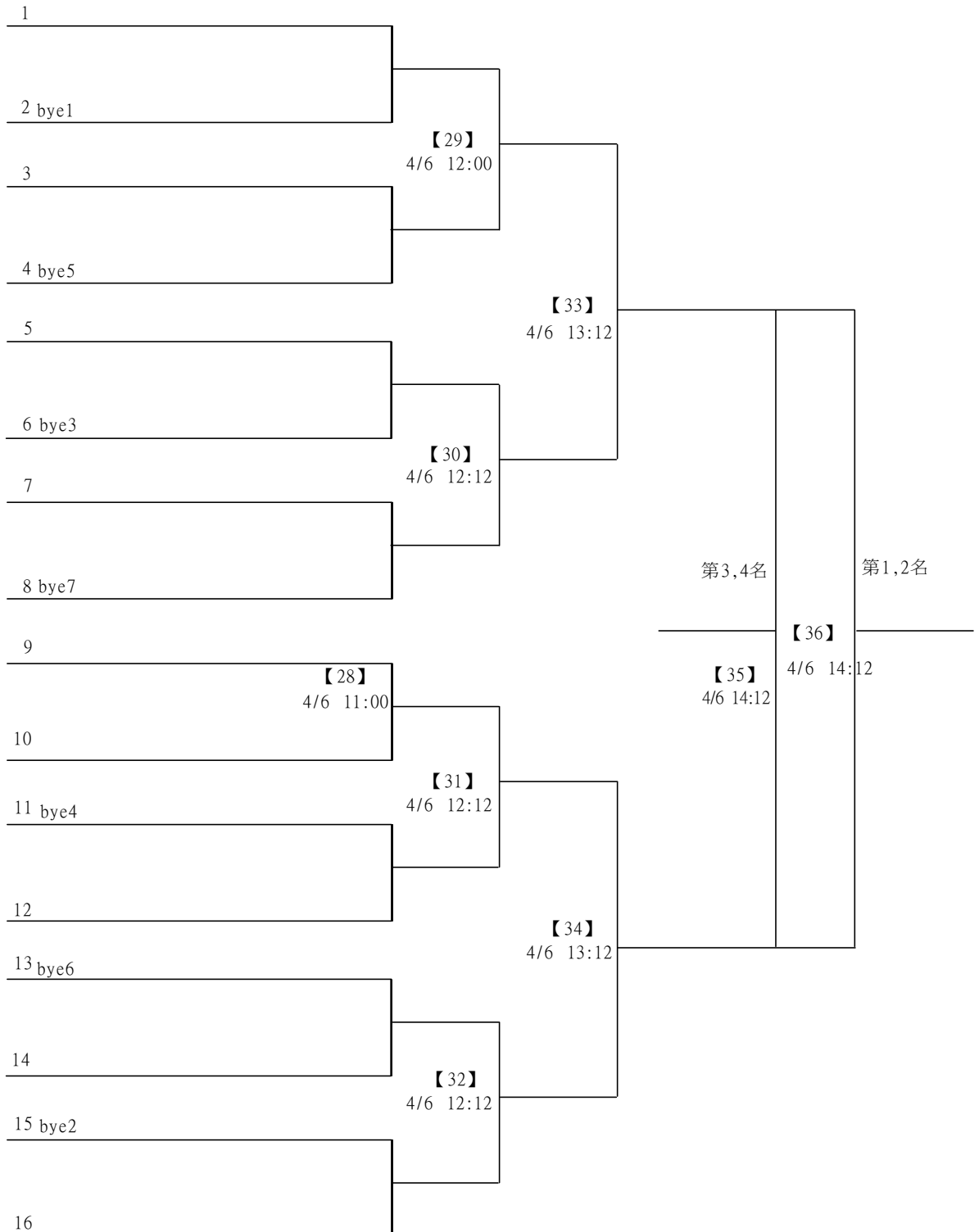

2025富宇建設DEFI羽球錦標賽

取3名

31歲以上組男雙 共9籤

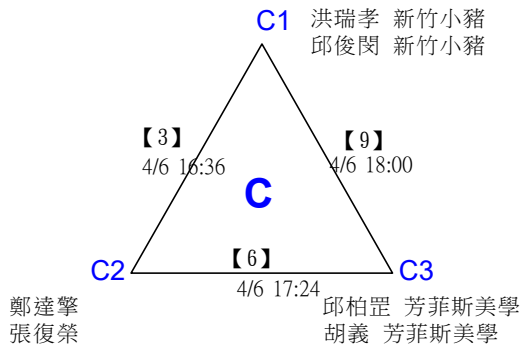
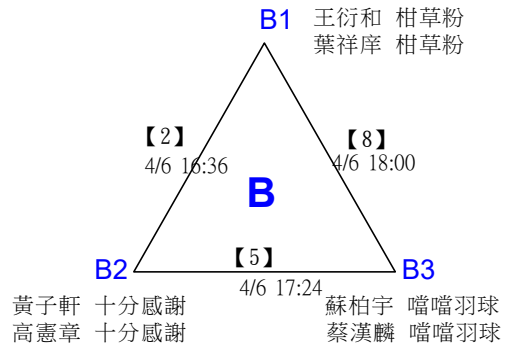
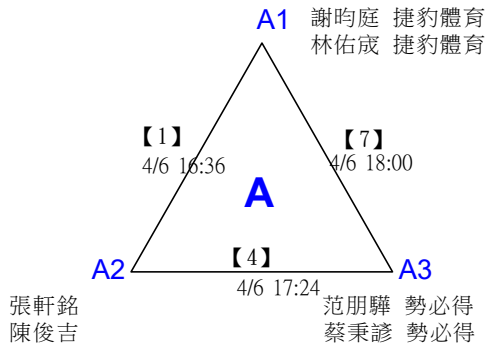

2025富宇建設DEFI羽球錦標賽

取3名

31歲以上組男雙

決賽：三角取一，直接帶入。

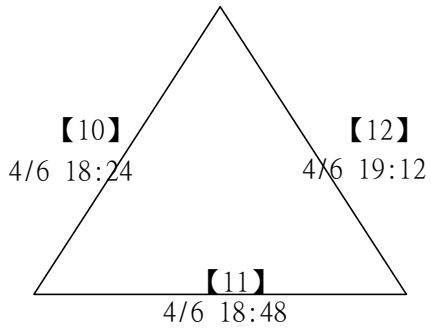

2025富宇建設DEFI羽球錦標賽

取3名

31歲以上組混雙 共9籤

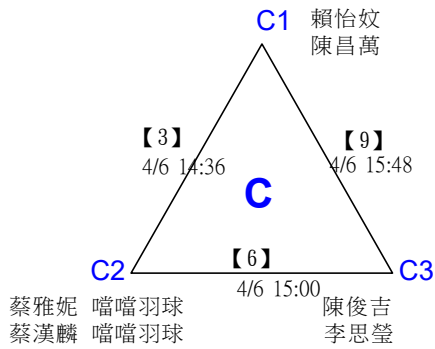
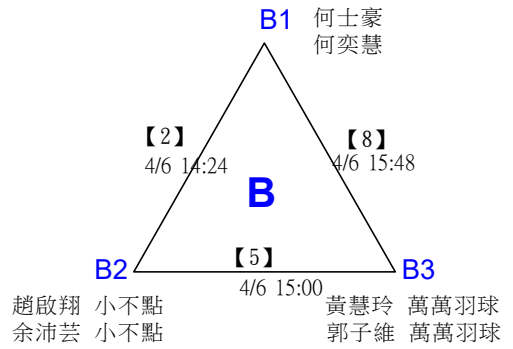
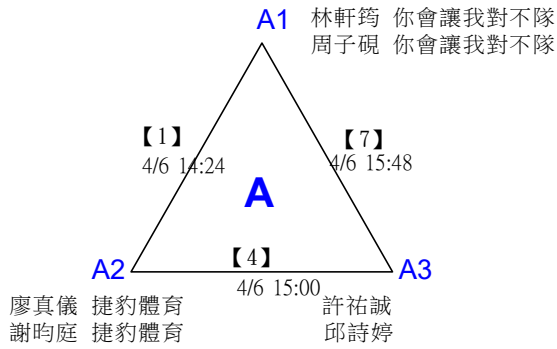

2025富宇建設DEFI羽球錦標賽

取3名

31歲以上組混雙

決賽：三角取一，直接帶入。

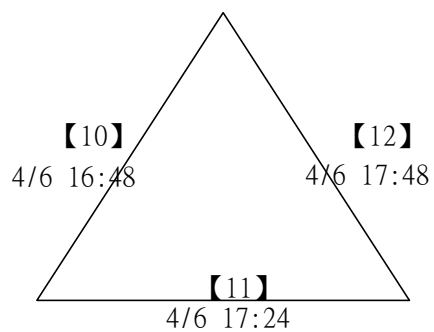

2025富宇建設DEFI羽球錦標賽

取8名

公開組混雙 共24籤

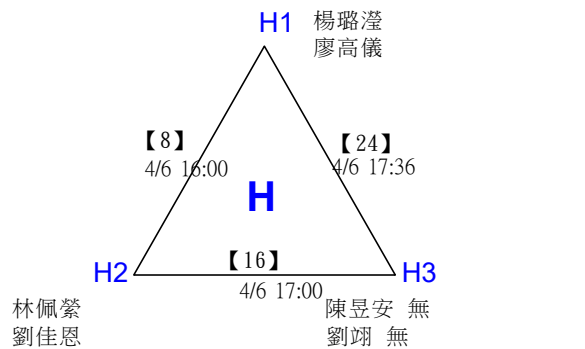
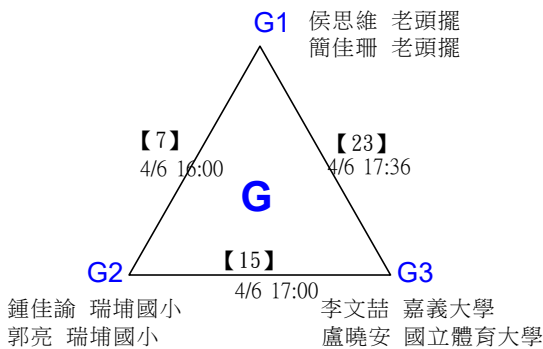
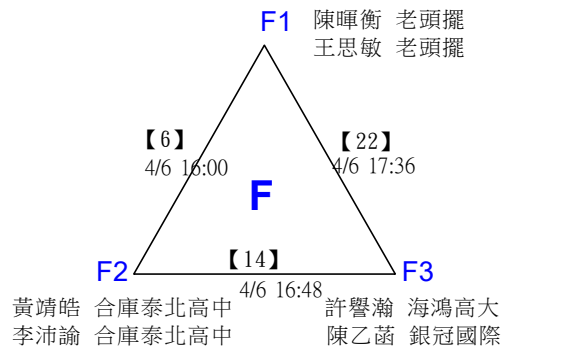
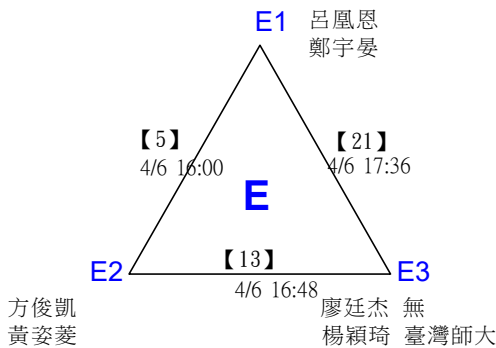
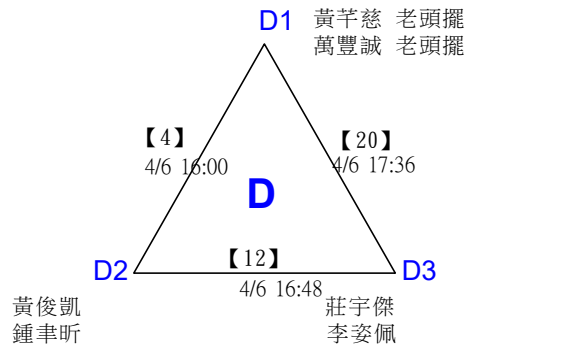
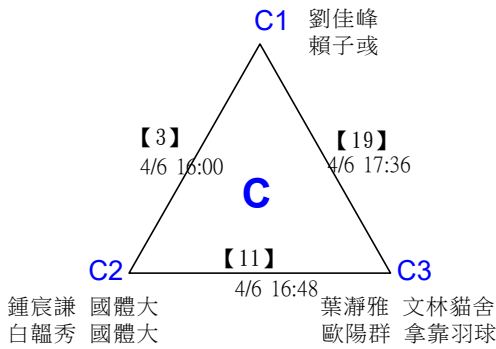
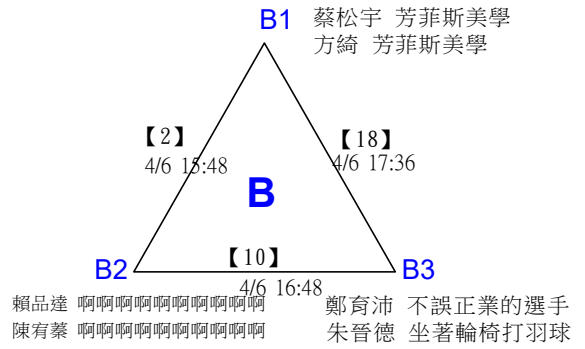
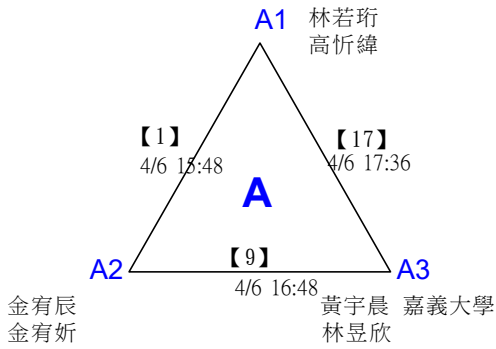

2025富宇建設DEFI羽球錦標賽

取8名

公開組混雙

決賽：三角取一，抽籤決定位置。

